

# Apache Labs LLC



## ANAN-7000DLE User Guide

**This document contains the words Apache, ANAN-10, ANAN-10E, ANAN-100, ANAN-100D, ANAN-200D, ANAN-7000DLE, ANAN-8000DLE in reference to the Apache Labs Transceiver products**  
<http://www.apache-labs.com>

In cooperation with VK6PH, NRØV, W5WC, K5SO  
and the OpenHPSDR Hardware and Software Projects  
<http://openhpsdr.org>

all images and manufacturer data is copied here with permission of the owner

**New!** [Apache Labs Community Forum](#)

## Contents - ANAN-7000DLE Users Guide

Apache Labs LLC, Inc. - Declarations of Conformity.....	5
Apache Labs Products CE and RTTE Certified.....	5
Heat Dissipation.....	5
Clarification CCS [30W]/ICAS [100W] operation.....	5
<b>1. ANAN-7000DLE Architecture.....</b>	<b>6</b>
7000DLE Design Team.....	6
7000 Specifications.....	6
PA board.....	6
General Specifications.....	6
Electrical Specifications.....	7
Mechanical Specifications.....	7
Receiver Specifications.....	7
Transmitter Specifications.....	7
Additional I/O Connections.....	7
Ethernet Command and Control.....	8
Noise Blankers.....	8
Noise Reduction.....	8
Minimized Latency.....	8
Two Phase Synchronous ADCs.....	9
PureSignal Pre-Distortion.....	9
<b>2. Introduction.....</b>	<b>10</b>
Introduction.....	10
Minimum Requirements.....	10
Suitable routers or LAN Network switches.....	10
Ethernet Connection.....	11
Simple Network Setup.....	12
Recommended Software.....	12
ANAN-7000DLE Front Panel.....	13
ANAN-7000DLE Back Panel.....	14
ANAN-7000DLE Antenna Connectors.....	15
ANAN-7000DLE RCA Connectors.....	16
ANAN-7000DLE Open Collector Connector.....	17
<b>3. PowerSDR MRX PS Instructions.....</b>	<b>18</b>
Hardware Setup.....	18
Software Setup.....	19
PowerSDR mRX PS Installation Wizard.....	20
PowerSDR mRX PS Console.....	20
PowerSDR mRX PS Setup Menu.....	21
PowerSDR mRX PS IP Address.....	22
<b>4. SSB Phone Operation.....</b>	<b>23</b>
Connecting a suitable Microphone.....	23
MIC Adapters.....	24
Setting up PowerSDR for Phone Operation.....	25
Selecting Transmit Profile.....	25

Adjusting Mic Gain.....	25
Tune.....	26
VOX.....	26
Transmit Filter.....	26
Antenna Control menu.....	27
BPF1/LPF Filters Control menu.....	28
<b>5. CW Operation.....</b>	<b>29</b>
Sample Rate.....	29
Iambic B.....	30
CW Paddle Connection.....	31
CWU/CWL.....	31
Select Operating Frequency.....	32
Set Drive Level.....	32
Break-in Delay.....	33
Sidetone Level.....	34
Tuning.....	34
Tune/SWR/Output.....	35
<b>6. Linear Amplifier connection.....</b>	<b>36</b>
PTT Out.....	36
Linear Amplifier Keying ISOLATION adapters.....	36
ALC.....	36
OpenCollector BCD keying.....	37
<b>7. Transverter.....</b>	<b>38</b>
XVTR T/R port.....	38
<b>8. PureSignal Adaptive pre-distortion information.....</b>	<b>39</b>
Using PureSignal Adaptive Predistortion.....	40
PureSignal update for PowerSDR mRX PS.....	41
<b>Reference materials.....</b>	<b>43</b>
Apache Labs Web Forum.....	43
Nige G7CNF.....	43
Apache Yahoo Support Group.....	43
OpenHPSDR Group.....	43
Apache Service and Repair.....	43
Manual Calibration Procedure.....	44
Computer Performance.....	45
Warranty.....	46
IMPORTANT.....	46
MARS operation.....	47
APIPA Automatic Private IP Addressing.....	47
Apache Labs Orion MkII PCB.....	48
ANAN-7000DLE PA/FILTER PCB.....	49
<b>Appendix.....</b>	<b>51</b>
Apache Schematics.....	51
Balanced Audio Input.....	51
Independent versions of PowerSDR software.....	51



Multiple independent .xml databases.....51  
Updating the ANAN-7000DLE Firmware.....52  
HPSDRProgrammer v2.0.4.10.....53  
Assign Static IP Address using HPSDRProgrammer.....54  
HPSDRBootloader v2.0.....55  
Assign Static IP Address using HPSDRBootloader.....56

**Note:** Customer is responsible for FEDEX shipping and all local Customs, Tariff, VAT, Taxes and incidental charges within their delivery [address] Country. Please contact Apache Support <[support@apach-labs.com](mailto:support@apach-labs.com)> for details regarding your order or shipping charges.

## Apache Labs LLC, Inc. - Declarations of Conformity

The ANAN-7000DLE complies with FCC Part 97 rules for the Amateur Radio Service. It has been confirmed by the relevant authorities that the ANAN-7000DLE DOES NOT require FCC certification. Under rule 97 Amateur radio equipment with the exception of amplifiers and scanning receivers are exempt from certification, however, must conform to rule 97 which states that harmonic and spurious emissions must be below 43dB of the transmitted out up to 30MHz and 60dB beyond that.

## Apache Labs Products CE and RTTE Certified

CE & EC Radio and telecommunications terminal equipment [RTTE] Certification.

We are pleased to announce that the ANAN series HF & 6M SDR transceivers including the ANAN-7000DLE is now CE and RTTE certified as per EU trade directives, All ANAN radios are RoHS compliant as well, we ensure that our products are of the highest quality and meet international standards of quality and compliance.

### Important Operation tips

- Do not cover rear or bottom fan and ventilation holes. Proper air circulation throughout the ANAN Transceiver is necessary to prevent possible overheating and failure.
- Calibrate power output to 100W using a suitable 50 ohm Dummy Load. Operating at higher levels will damage the radio. Please review CCW and ICAS specifications on this page.
- Data/AM/FM and other continuous duty modes must be operated at 30W or less to remain within the operational limits of the radio.
- Input voltage must be **13.8vdc +/- 5%**, well regulated at **30A Peak** and proper **POLARITY** must be observed.
- DISCONNECT the Antenna during Thunderstorms or when not in use.
- Please ensure that you select the correct model during software setup.
- Install the supplied rubber feet on the bottom of the case for proper cooling.

## Heat Dissipation

The ANAN-7000DLE uses a heavy duty Aluminum extruded housing to dissipate heat with temperature controlled internal and optional external fan.

**Ventilation holes in the bottom of the ANAN-7000DLE must be clear of obstructions so that the internal fan can pull hot air from inside the unit.**

**The ANAN-7000DLE should not be operated at greater than 30% of it's rated power when used for extended duty cycles such as digital, RTTY, AM, and FM operation.**

## Clarification CCS [30W]/ICAS [100W] operation

RTTY/AM/FM, **CCS** [Continuous Commercial Service] **30W**

SSB, CW and all **ICAS** modes [Intermittent Commercial/Amateur Service] **100W PEP**

The Power Amplifier MOSFET transistor has characteristics that far exceed the needs of normal Transceiver operation. They are quite rugged. However, other internal components such as the Toroids, Filters, Integrated Circuits, and some small SMT parts must also be considered when high duty cycle modes are in use. There are three voltage rails all of which have thermal shutdown protection built in.

## 1. ANAN-7000DLE Architecture

### 7000DLE Design Team

Phil Harman, VK6PH  
Doug Wigley, W5WC  
Dr. Warren C. Pratt, NR0V  
Kjell Karlsen, LA2NI  
Abhishek Prakash  
Dr. Joe Martin, K5SO  
John Melton, GØORX/N6LYT  
Adam Farson AB4OJ/VA7OJ

### 7000 Specifications

#### The ANAN-7000DLE – Second to none!

- Using **Direct Down Conversion** with an ultra low phase noise clock yields an RMDR of 116dB @ 2Khz separation, this means that close in weak signals will not be masked by the receiver's phase noise.
- The transmitter specifications are also off the chart, use of a new **16-bit DAC with an ultra low noise clock source results in transmit phase noise better than any other product available in the market.**
- Use of **LDMOS drivers and an optimized final Amplifier stage with adaptive Predistortion Algorithm (PureSignal) yields transmit IMD of better than 60dB, this is at least 20dB better than any Class A transmitter and over 30dB better than the competition.**
- **Use of two 16-bit phase synchronous ADCs allow for advanced applications such as Diversity reception for ultimate noise mitigation and effects of signal fading.**

The ANAN-7000DLE HF & 6M 100W SDR Transceiver offers top of the line performance in a compact rugged package, it is based on the work of the OpenHPSDR community.

#### **The new PA board** incorporates the following updates over the previous 100W generation:

- PA Gain redistribution for better IMD
- Thermally compensated Bias
- Current/Voltage/Temp Sensors
- Temp controlled internal and option for external FAN
- Independent BPFs and 6M LNAs for each ADC, option to ground ADC2 on Tx

#### **General Specifications:**

- Architecture: Direct Sampling DDC/DUC Transceiver

- Interface: Ethernet
- Phase Noise (Clock): -149dB @ 10Khz
- TCXO Stability (Typical): /- .1 PPM
- Modes: CW, SSB, NFM, AM, Digital
- Antenna Ports: 3 - BNC 50 ohm Software Configurable Ports, 2 - BNC ADC1 receive only antenna ports, 1 – BNC Transverter receive only port, 1 - BNC for ADC2
- Frequency Resolution: 1 Hz

### Electrical Specifications:

- 13.8v DC @ 25A, 3A Receive/25A Transmit

### Mechanical Specifications:

- 5Kg (approx. Weight)
- Dimensions: 276MM (L) x 79MM (H) x 265MM (W) (Not including extrusions)
- Rugged Aluminium Extrusion with Temperature controlled internal/External (Optional) Fan.

### Receiver Specifications:

- Receiver Architecture: Direct Down Conversion
- Dual 16 bit Phase Synchronous ADCs
- Independent filter banks for each ADC
- 6M LNAs
- Frequency Coverage: 9Khz to 60Mhz
- Attenuator: 1-30dB step attenuator
- Reciprocal Mixing Dynamic Range (RMDR): 116dB @ 2Khz offset
- Receiver Phase noise: -149dB @ 10Khz
- Image rejection: 90dB
- Hardware support for 7 independent receivers assignable to either ADC

### Transmitter Specifications:

- Transmitter Architecture: Direct Up Conversion
- DAC Resolution: 16 bit
- RF Output Power: 100W SSB, CW, FM, RTTY, Digital; 1-30W AM
- IMD3 typically -68dB below PEP @ 100W output on 20M
- Harmonics: Typically better than -43dBc on HF and -60dBc on 6M
- Carrier and Opposite Sideband Suppression: Better than -80dBc
- Transverter IF Output: 0db to 15dB

### Additional I/O Connections:

- RCA - Line In, PTT In, PTT Out, 2 – DIG inputs

- DB9F - 7 Software Configurable Open Collector Outputs
- SMA – XVTR output, 10Mhz Reference Input
- 3.25mm Barrel Mic, CW Key, Headphones and two 6.25mm Speaker Outputs
- RJ45 - Ethernet LAN Connector

### **Ethernet Command and Control:**

The ANAN Transceivers use a Gigabit Ethernet interface to connect to your LAN. Ethernet command and control features huge bandwidth, better noise isolation from the PC, and networked radios with remote access. Beta testers report good performance across 802.11n WiFi links.

### **Noise Blankers:**

The PowerSDR provides a choice of two Wideband Noise Blankers in addition to the new Spectral Noise Blanker by Warren NR0V.

The two Wideband Noise Blankers are:

- **A pre-emptive Blanker** which effectively slews it's output to zero before an impulse arrives, and then slews back to full amplitude after the impulse passes.
- **An Interpolating Noise Blanker** which is also pre-emptive, but has modes such as Linear interpolation of the signal during the impulse. Wideband Noise Blankers, while they are the best choice in some situations, have a well-known issue that they may become ineffective in the presence of strong adjacent signals, for example during a busy contest. The Spectral Noise Blanker cleverly overcomes this deficiency by using Linear Predictive Coding (LPC). LPC provides the capability to predict a sequence of samples by analyzing the spectral content of the samples before and after the sequence. By comparing the predictions with the measured samples, impulses are detected and blanked or reduced. The LPC is again used to predict what the signal waveform should be during the incident pulse and thereby replace the corrupt samples with clean signals.

### **Noise Reduction:**

Two types of Noise Reduction algorithms are provided to minimize random noise.

The first is a special implementation of a Least Mean Square (LMS) algorithm and the second is a new Spectral Noise Reduction NR2 (2015). LMS algorithms are used in most Software Defined Radio's and Digital Signal Processing modules due to their relatively simple implementation and low compute requirements. However they use only the input signal as a reference to identify the output and therefore are unable to achieve optimal signal-to-noise ratios and they sometimes yield an unusual "in the barrel" or "underwater" sound. The new Spectral Noise Blanker specifically uses sophisticated statistical models of speech and noise to produce superior signal-to-noise ratios and vibrant sound output.

### **Minimized Latency:**

In Software Defined Radio's, filtering usually contributes the most latency. There are two reasons; (1) large sets of samples, "buffers", are normally collected before executing the filters so that efficient FFT algorithms can be used, and (2) sharp "brick-wall" linear-phase filters inherently have long latency, no matter how cleverly they are implemented. Both these issues have been addressed and conquered in the ANAN-7000DLE Transceiver. Small "buffers", requiring little collection time, can now be used even while retaining the very sharp "brick-wall" filters. In addition, the option of using very low-latency "minimum-phase" filters is provided. In almost all situations, laboratory and on-air testing have demonstrated no discernible difference in performance between linear-phase and minimum-phase filters. With filters as sharp as you desire, **sub-20ms receive latencies are now possible**, compared to the best of conventional DSP radio's and must better than competing Software Defined Radio's.



## **Two Phase Synchronous ADCs**

ANAN-7000DLE includes two phase synchronous front ADC's to enable Diversity reception and other advanced applications. The Transmit chain is designed keeping in mind the unique "PureSignal" Linearization and pre-distortion.

## **PureSignal Pre-Distortion:**

There is no truly Linear RF amplifier. The Non-linearity in an amplifier shows up as Intermodulation Distortion (IMD) Wikipedia reference: <https://en.wikipedia.org/wiki/Intermodulation> within and outside the transmitted bandwidth. There are many challenges to reduce IMD, hence, most manufacturers of Amateur Radio Equipment do not specify their IMD, or use inefficient Class-A options that lower IMD at the expense of power. The ANAN-7000DLE was designed with the unique PureSignal Linearization (Pre-Distortion) to achieve an astounding -68dBm IMD on 20M at full 100W output. This achievement in design is an improvement of at least 25 to 30dB or approximately 1000 times lower distortion than conventional "Class-C" capable flagship transceivers.

## 2. Introduction

### Introduction

The ANAN-7000DLE Amateur Radio Transceiver is a modern direct-down-conversion **[DDC]** receiver, and direct-up-conversion **[DUC]** transmitter, Software Defined HF transceiver plus 6 Meters. The ANAN-7000DLE has a proud heritage from the TAPR Hermes Transceiver introduced in 2012. The ANAN-7000DLE was cooperatively designed by the OpenHPSDR Team and Apache Labs. Please see "Contributing Members".

The Apache Labs ANAN equipment includes the "Hermes", "Angelia", and "Orion" designs in a series of new transceivers. The ANAN-7000DLE is operated on a 100/1000Mbps Ethernet interface to the host PC. The ANAN does not use a Firewire™, or a USB interface to the host PC.

ANAN firmware updates can be easily installed via the radio's standard Ethernet connection, eliminating the need for special mechanical or programming adapters. It is not necessary to open the 7000DLE cabinet to update the firmware. A "Bootloader" switch has been added to the bottom panel of the 7000DLE for ease of future updates.

ANAN Transceivers can be used with a number of different PC Software Defined Radio programs including those written for Windows®, Linux, MacOS/X®, Android, RaspberryPi, and other operating systems. The most popular at this time is "PowerSDR mRX PS" (PowerSDR enhanced with multiple receivers and PureSignal Linearization) and the pihpsdr-Controller designed by John Melton G0ORX.

**Note:** Please see the Apache Labs webpage: <https://apache-labs.com/index.php>

### Minimum Requirements

#### Computer basic requirements

- Intel i3, 2.8Ghz or better [recommended].
- 4GB Ram or more [recommended].
- 1280 X 1024 display screen [or higher] resolution recommended
- Windows 7 or newer. It is possible that some older machines or minimally configured "Netbook" computers may not give satisfactory performance, regardless of processor speed.
- Computer with Full Duplex Ethernet NIC card capable of 1000 BaseT/Gigabit Ethernet is recommended.
- **Full Duplex Ethernet switch** or router with 1000Mbs Ethernet port recommended.
- Shielded CAT6 [recommended] Ethernet patch cable to connect the ANAN to an Ethernet switch, router, or computer.

Older and slower Desktop, Laptop, Tablets, or Notebook computers may require considerable optimization before they can provide necessary performance for trouble free SDR operation. This optimization may require that certain applications and services be stopped in order for the software to operate correctly. It is possible some older or slower machines will not give satisfactory performance, regardless of processor speed.

### Suitable routers or LAN Network switches

A Full Duplex wired or wireless Ethernet with sufficient ports to connect the host computer and the ANAN at 100 BaseT. An optional Full Duplex Ethernet switch with 1000 BaseT Internet connectivity may be required if additional Ethernet ports are needed. Ethernet **HUBS** will **NOT** work properly for this software application.

## Ethernet Connection

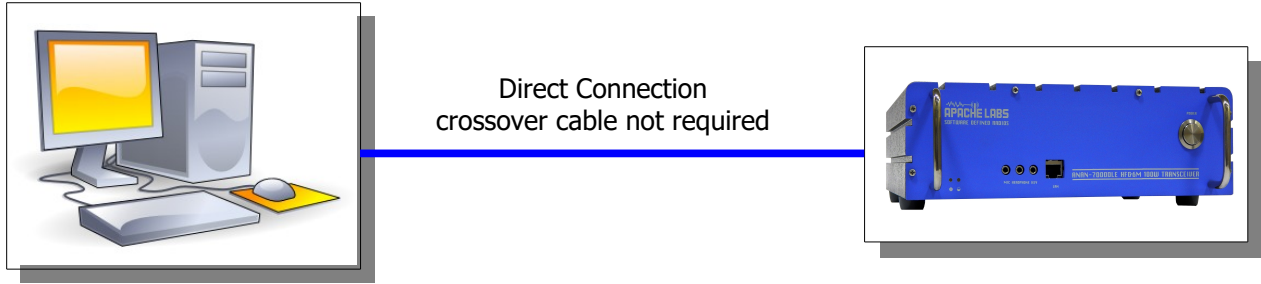

ANAN should be connected directly to a dedicated Ethernet port on the host PC or to a port on a suitable Ethernet router or switch. Connection to a dedicated Ethernet port is shown above.

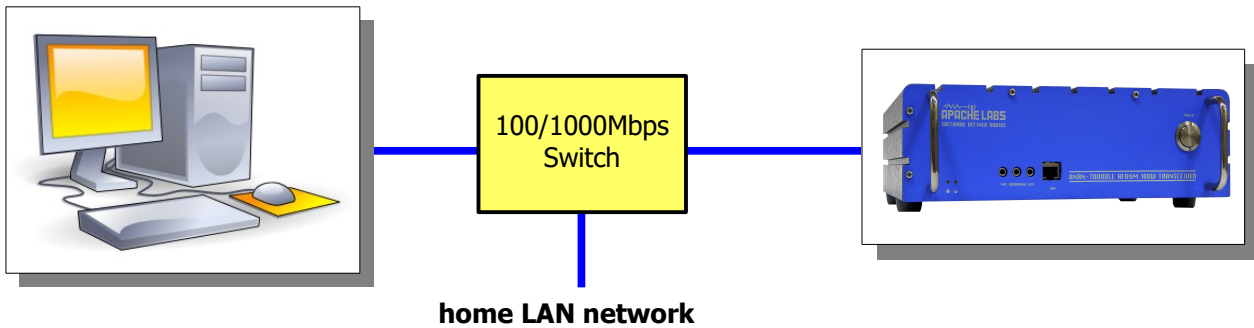

For direct connection to a dedicated Ethernet port, a CAT 6a Ethernet cable is used. Note that a 'crossover' cable is **not** necessary.



**Note:** The Ethernet switch should be capable of operating in **full duplex** mode at 1000 BaseT[Gigabit]. A 100 BaseT Ethernet switch may be used in the interim, but if a new purchase is planned then a **1000 BaseT [Gigabit] switch is recommended**. An Ethernet "HUB" will **not** work properly and is **not** recommended.

**Note:** an **Ethernet Surge Protector is recommended** for all delicate Ethernet equipment.

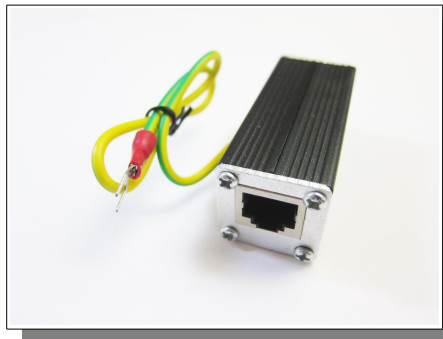

Example: LAN Ethernet Surge Protector used to protect rig

## Simple Network Setup

The Apache-Labs ANAN Transceivers are designed to work via Ethernet cabling on [a] "Local Area Network" or [b] directly connected to your PC. Ethernet simplifies the installation, and configuration of hardware and software, making the installation basically "plug and play". **No sound card interface wiring, no Firewire® cards or drivers, no USB ports or drivers are needed.** It just works!

- For the most basic network, you don't need any external hardware other than an Ethernet cable between your Windows PC LAN port and your Transceiver's LAN port.
- The ANAN Transceiver will query for a "DHCP" network address or an **APIPA** address [discussed in Appendix below]
- Hardware Requirements  
**13.8vdc minimum, 25A [Recommended]**  
 Note: some switching DC supplies create objectionable EMI/RFI which may degrade performance of the ANAN transceiver.
- Ham band resonant 50 ohm **HF antenna** for normal Ham Radio operation.
- Suitable **100W Dummy Load** (or greater) required for PA calibration.
- PC condenser or dynamic microphone terminated in 3.5mm - 1/8" plug, for phone operation.
- CW key terminated in 3.5mm - 1/8" Stereo plug, for CW operation.
- A set of stereo speakers or stereo headphones with a 3.5mm - 1/8" stereo plug.
- **Note:** the Front Panel connections to the 7000DLE are 3.5mm - 1/8" stereo jacks.



## Recommended Software

- Windows 7, 8, or 10 recommended.
- Microsoft .NET 2.0 & 4.0 Framework required.
- OpenHPSDR PowerSDR mRX PS (multi-receiver with PureSignal)
- OpenHPSDR [Software and download information](#)

● Windows XP, 7, 8, 10	● PowerSDR™, Thetis, KISS Konsole
● Linux	● cudaSDR, cuSDR, ghpsdr3, GnuRadio, KIXX
● Android	● "OpenHPSDR" by John Melton GØORX/N6LYT
● Java	● "openhpsdr" by John Melton GØORX/N6LYT
● PiHPSDR-Controller (RaspberryPi)	● "pihpsdr" by John Melton GØORX/N6LYT
● MAC	● N/A

## ANAN-7000DLE Front Panel

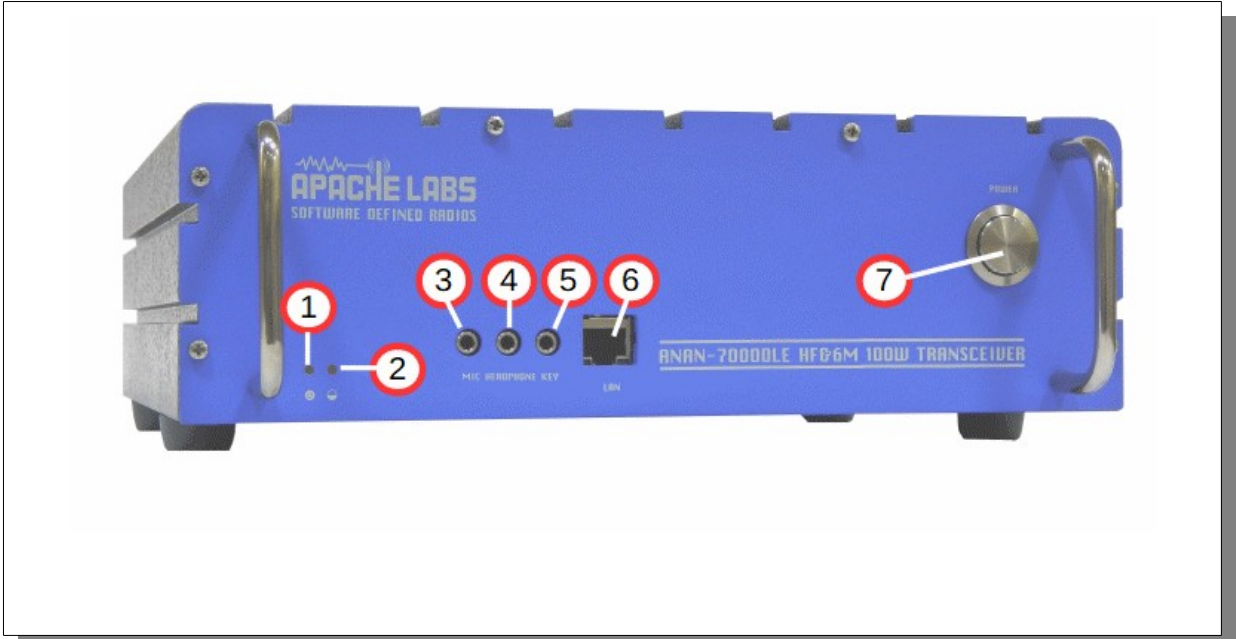

ANAN-7000DLE Front Panel connections

Connector Number	Connector Detail
1	Power on LED
2	FPGA clock activity LED
3	Microphone 3.5mm 1/8" Stereo with PTT
4	Phones 3.5mm 1/8" Stereo
5	CW Key/Paddles
6	100/1000BT LAN connection RJ-45
7	Power on/off switch

## ANAN-7000DLE Back Panel

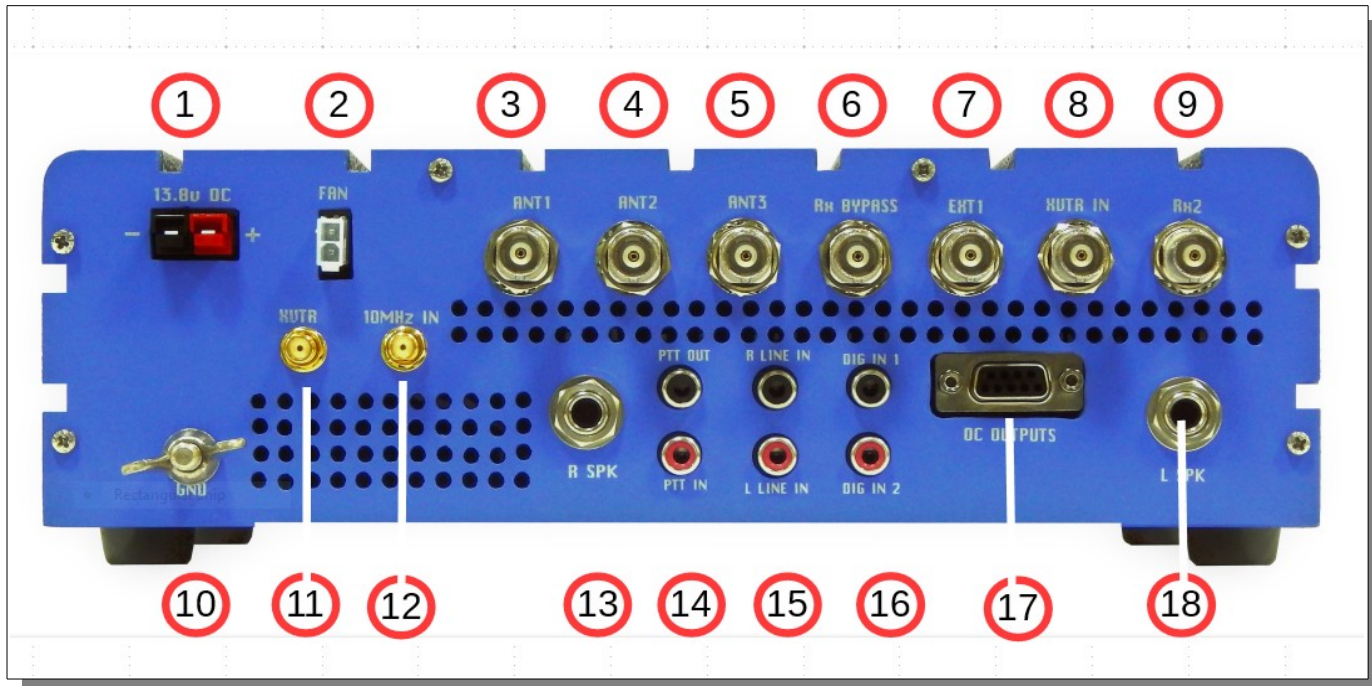

ANAN-7000DLE back panel details

Connector Number	Connector Detail
1	PowerPole® 13.8vdc 25A Power Supply connection
2	External Fan connector (optional) mating plug TE#158619-2
3	ANT-1
4	ANT-2
5	ANT-3
6	Rx Bypass
7	EXT1
8	XVTR IN
9	Rx 2
10	GND
11	XVTR OUT
12	10Mhz IN
13	Right Speaker 1/4" jack
14	PTT IN and PTT OUT
15	Right (Audio) Line IN, Left (Audio) Line IN (only Left Audio is used)
16	Digital IN 1, Digital IN 2 (transmit inhibit, straight key)
17	Open Collector 9 pin connector
18	Left Speaker 1/4" jack

**ANAN-7000DLE Antenna Connectors**

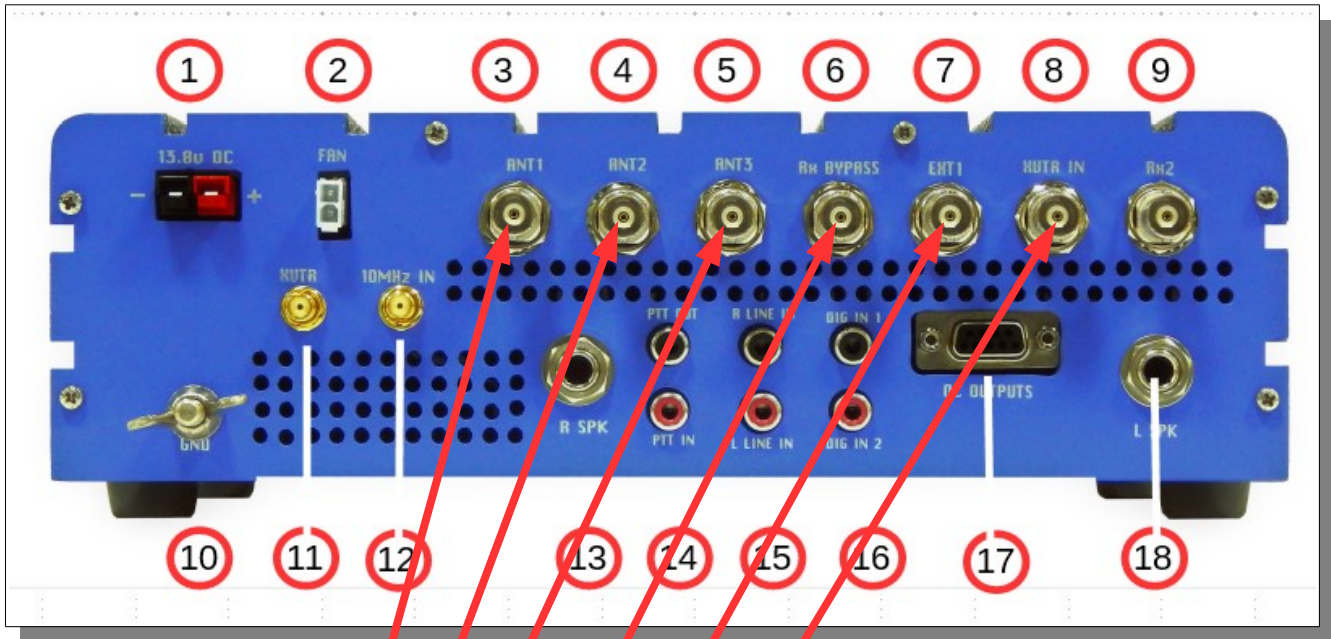

**HPSDR Setup**

General | Audio | Display | DSP | Transmit | PA Settings | Appearance | Keyboard | CAT Control | Tests

Hardware Config | HPSDR | ADC | Options | Calibration | ANAN Ctrl | **Ant/Filters** | Filters | RX2 | Navigation

**Antenna** | BPF1/LPF | BPF2

Antenna Control

Receive					Transmit					
Band	1	2	3	BYPS	EXT1	XVTR	Band	1	2	3
160m	<input checked="" type="radio"/>	<input type="radio"/>	<input type="radio"/>	<input type="checkbox"/>	<input type="checkbox"/>	<input type="checkbox"/>	160m	<input checked="" type="radio"/>	<input type="radio"/>	<input type="radio"/>
80m	<input checked="" type="radio"/>	<input type="radio"/>	<input type="radio"/>	<input type="checkbox"/>	<input type="checkbox"/>	<input type="checkbox"/>	80m	<input checked="" type="radio"/>	<input type="radio"/>	<input type="radio"/>
60m	<input checked="" type="radio"/>	<input type="radio"/>	<input type="radio"/>	<input type="checkbox"/>	<input type="checkbox"/>	<input type="checkbox"/>	60m	<input checked="" type="radio"/>	<input type="radio"/>	<input type="radio"/>
40m	<input checked="" type="radio"/>	<input type="radio"/>	<input type="radio"/>	<input type="checkbox"/>	<input type="checkbox"/>	<input type="checkbox"/>	40m	<input checked="" type="radio"/>	<input type="radio"/>	<input type="radio"/>
30m	<input checked="" type="radio"/>	<input type="radio"/>	<input type="radio"/>	<input type="checkbox"/>	<input type="checkbox"/>	<input type="checkbox"/>	30m	<input checked="" type="radio"/>	<input type="radio"/>	<input type="radio"/>
20m	<input checked="" type="radio"/>	<input type="radio"/>	<input type="radio"/>	<input type="checkbox"/>	<input type="checkbox"/>	<input type="checkbox"/>	20m	<input checked="" type="radio"/>	<input type="radio"/>	<input type="radio"/>
17m	<input checked="" type="radio"/>	<input type="radio"/>	<input type="radio"/>	<input type="checkbox"/>	<input type="checkbox"/>	<input type="checkbox"/>	17m	<input checked="" type="radio"/>	<input type="radio"/>	<input type="radio"/>
15m	<input checked="" type="radio"/>	<input type="radio"/>	<input type="radio"/>	<input type="checkbox"/>	<input type="checkbox"/>	<input type="checkbox"/>	15m	<input checked="" type="radio"/>	<input type="radio"/>	<input type="radio"/>
12m	<input checked="" type="radio"/>	<input type="radio"/>	<input type="radio"/>	<input type="checkbox"/>	<input type="checkbox"/>	<input type="checkbox"/>	12m	<input checked="" type="radio"/>	<input type="radio"/>	<input type="radio"/>
10m	<input checked="" type="radio"/>	<input type="radio"/>	<input type="radio"/>	<input type="checkbox"/>	<input type="checkbox"/>	<input type="checkbox"/>	10m	<input checked="" type="radio"/>	<input type="radio"/>	<input type="radio"/>
6m	<input checked="" type="radio"/>	<input type="radio"/>	<input type="radio"/>	<input type="checkbox"/>	<input type="checkbox"/>	<input type="checkbox"/>	6m	<input checked="" type="radio"/>	<input type="radio"/>	<input type="radio"/>

Antenna Control

SWR Protection

- Enable Protection
- Disable on Tune Pwr <35W
- ATT on Tx
- ATT: 31
- Rx BYPASS on Tx
- Disable HF PA
- Gnd BPF2 on Tx
- Enable XVTR HF

Reset Database | Import Database... | Export Database... | OK | Cancel | Apply

**ANAN-7000DLE RCA Connectors**

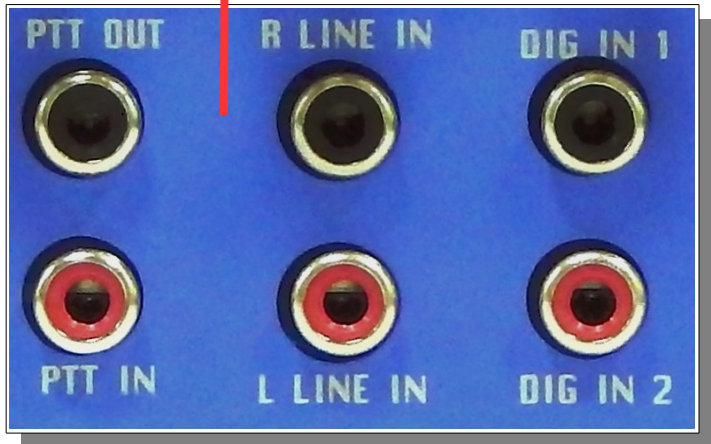
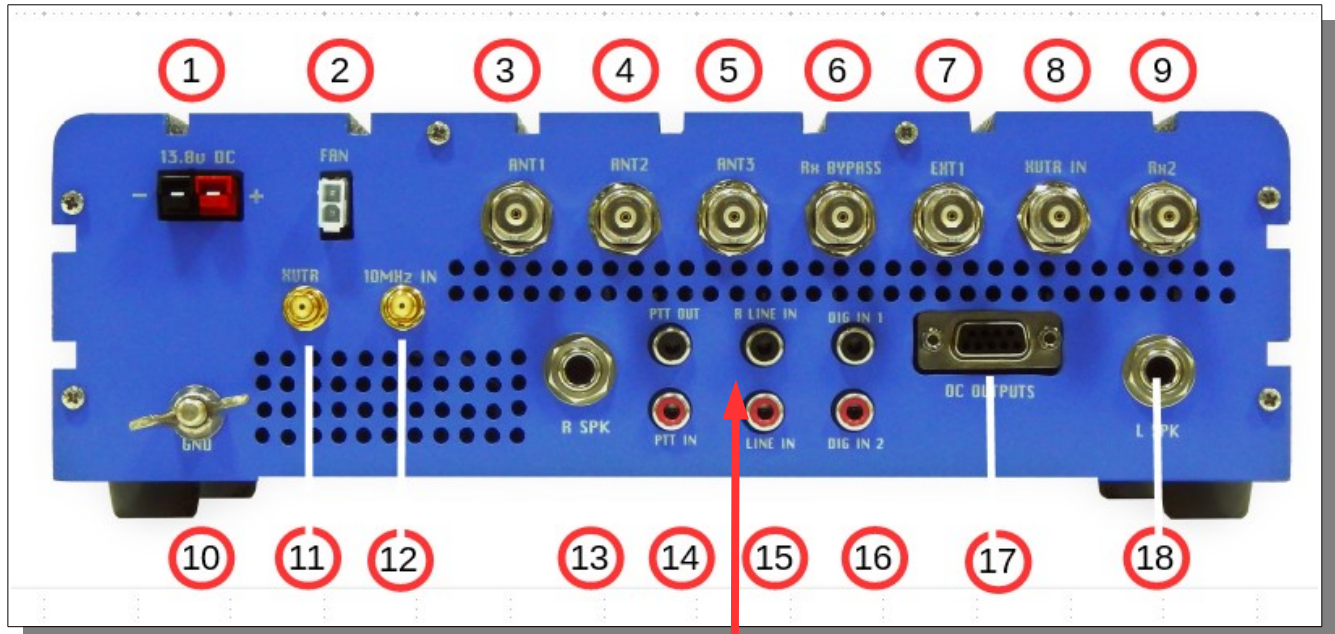

- The Digital Input Lines are buffered.
- Digital Input Line-1 used for TX Inhibit when switched to ground.
- Digital Input Line-2 used for CW Straight Key or Keyer connection.



## ANAN-7000DLE Open Collector Connector

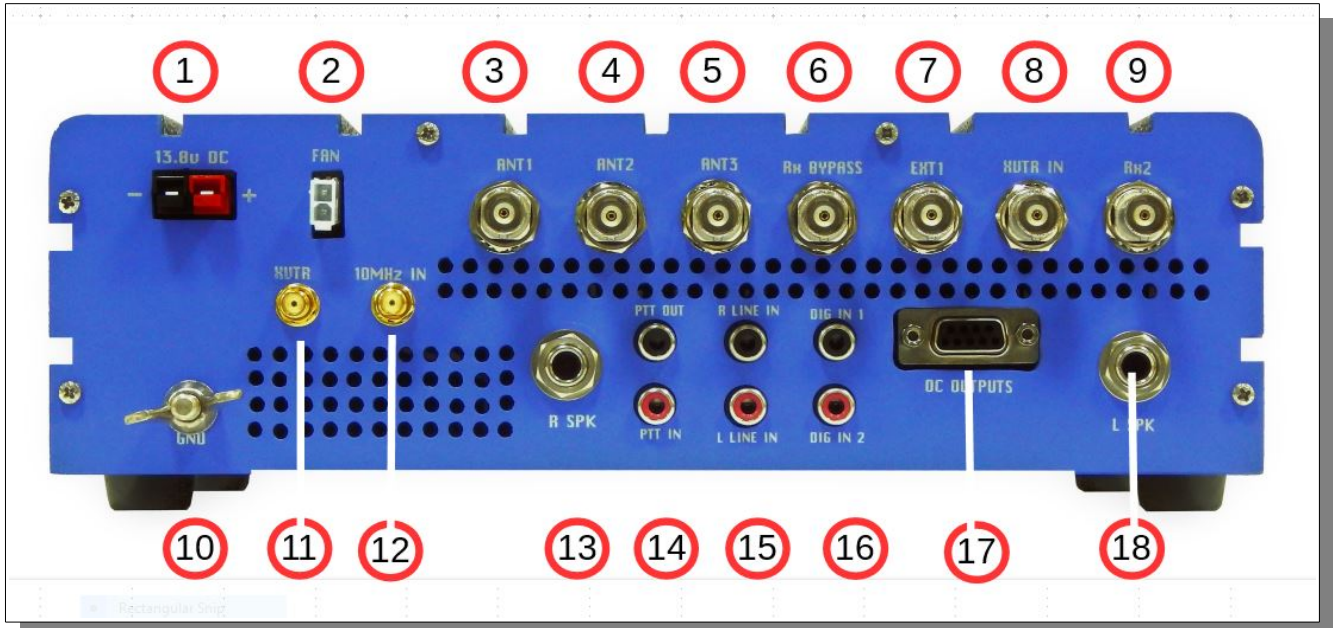

Open Collector pinout	
1	ground
2	OCRef
3	OC6
4	OC5
5	OC4
6	OC3
7	OC2
8	OC1
9	OC0

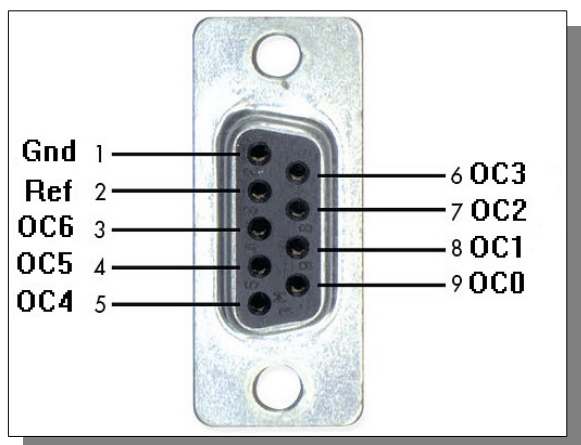

### 3. PowerSDR MRX PS Instructions

Refer to the Front and Back Panel illustrations

#### Hardware Setup

- The ANAN transceiver should be carefully placed to allow unobstructed airflow around and beneath the housing. Damage can occur if the ventilation openings on the bottom or chassis of the ANAN Transceiver are blocked. Allow room for airflow between the housing and other equipment.
- Connect the supplied 13.8VDC cable to the rear panel power connector and to a filtered 13.8VDC +/- 5%, power supply capable of providing up to 20A. **observe proper polarity**
- Connect a suitable ground cable to the rear panel ground terminal to your station RF ground, in accordance with good amateur practices.
- Connect a 50 ohm transmission line between the rear panel ANT1 SO-239 connection and a 50 ohm dummy load.
- Connect powered stereo speakers or a stereo headset to the front panel 1/8" (3.5mm) stereo jack.
- For **Phone** operation connect a condenser or dynamic **microphone** equipped with a 1/8"(3.5mm) plug into the front panel jack. Note that the wiring of this jack is software controlled in the Setup menu of PowerSDR.
- For **CW** operation, connect your favorite paddles to the **CW KEY** jack on the front panel.
- Connect an Ethernet cable between the front panel RJ45 LAN jack and your router, Gigabit switch, or PC Ethernet port. Note: the **Automatic Private IP (IP) Assignment (APIPA)** feature is incorporated in the firmware of the ANAN-7000DLE.

## Software Setup

Download the latest release from the TAPR [GitHub](#) repository. **PowerSDR mRX PS**

Start the Installer.

Note: You may be asked to install the full Microsoft .NET 4.x Framework if the Installer determines that your PC does not have the necessary .NET version installed. You may manually install the Microsoft .NET 4.0 Framework from [Microsoft .NET software](#)

After the installation completes, click on the desktop ICON to start PowerSDR mRX PS.

If this is a new install the program will begin optimizing the FFT3 DSP code called "WISDOM". **A DOS window FFT optimization** screen will appear. Exit the DOS window after you see the PowerSDR Console.

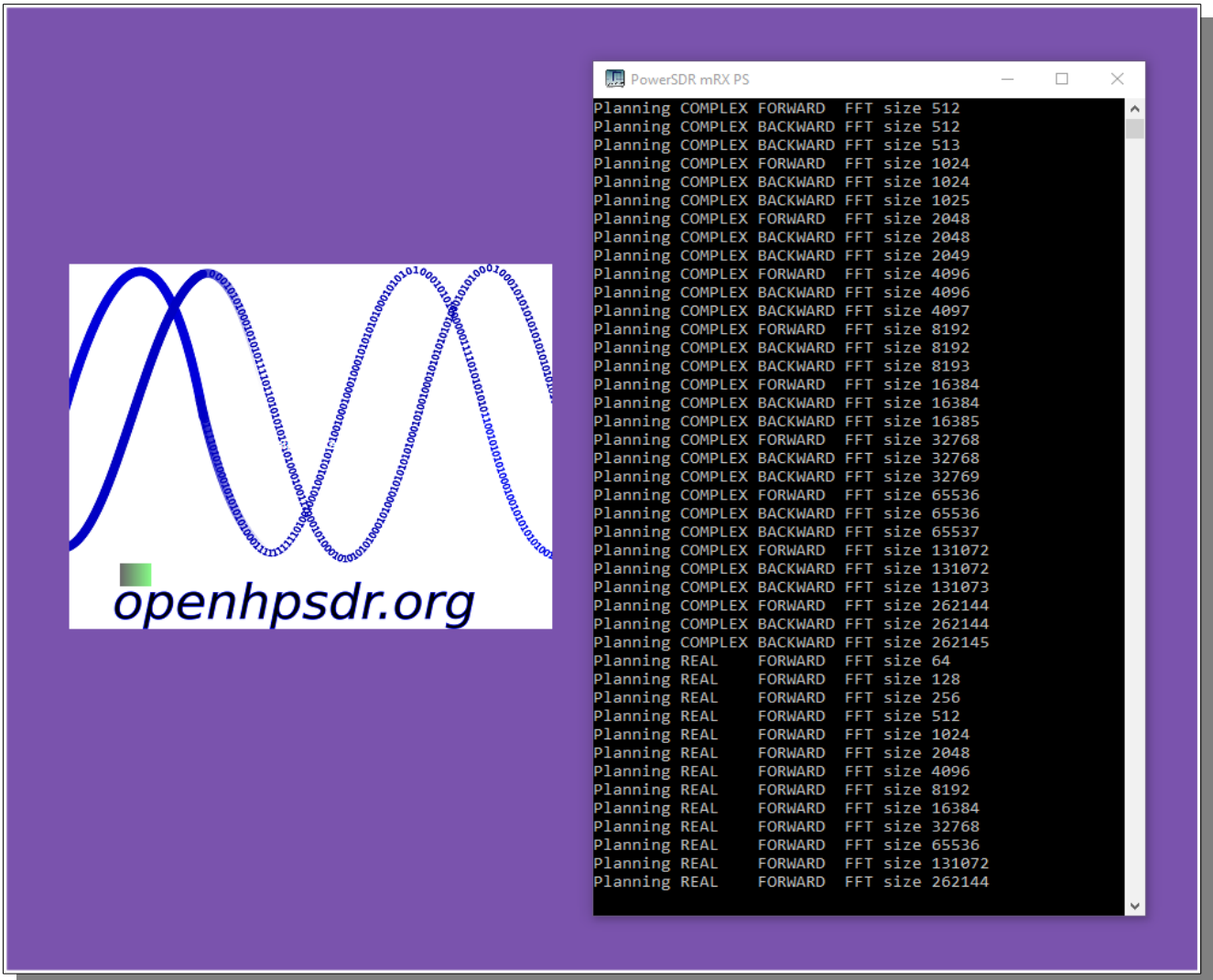

- The optimization **WILL** take several minutes.
- Turn on your power supply. Push the **POWER** button on the ANAN-7000DLE Transceiver.

## PowerSDR mRX PS Installation Wizard

If this is a new software install or the database.xml file is missing you will be presented with the Setup Wizard menu. Click on the ANAN-7000DLE button and then Next, Next, Finish.

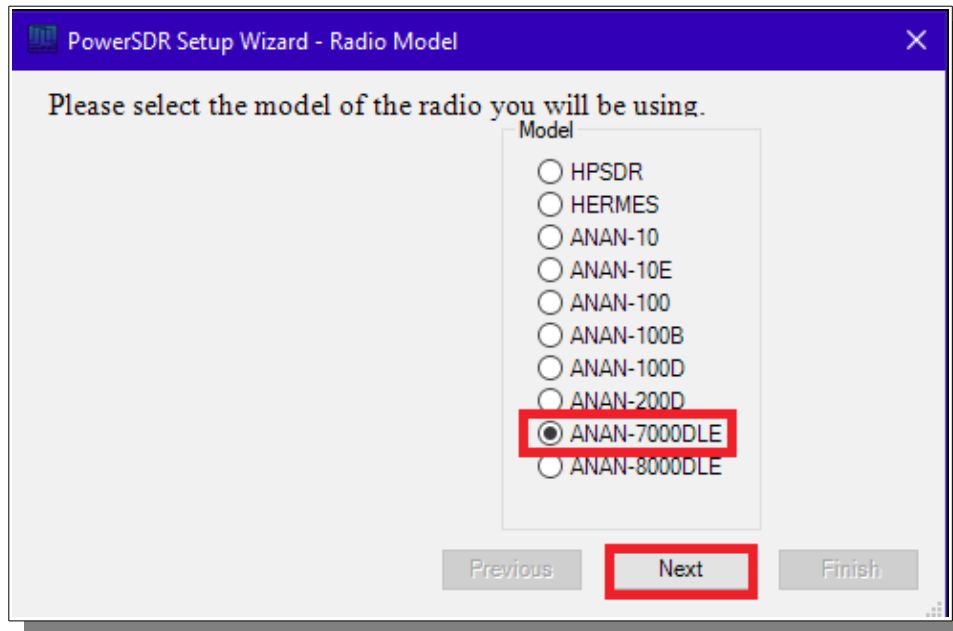

## PowerSDR mRX PS console

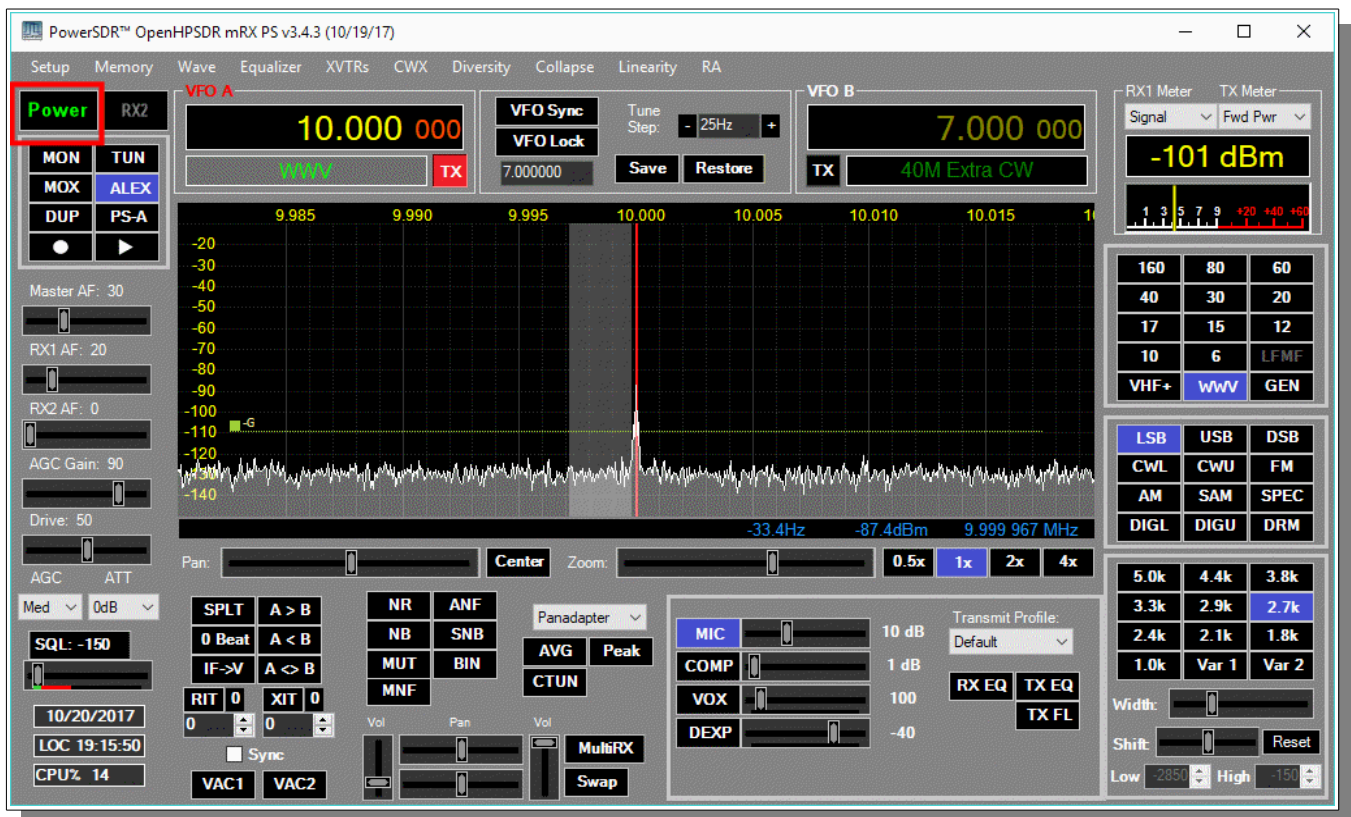

- Run **PowerSDR** then press the **Power** button.
- Click on the **Setup** menu.

## PowerSDR mRX PS Setup Menu

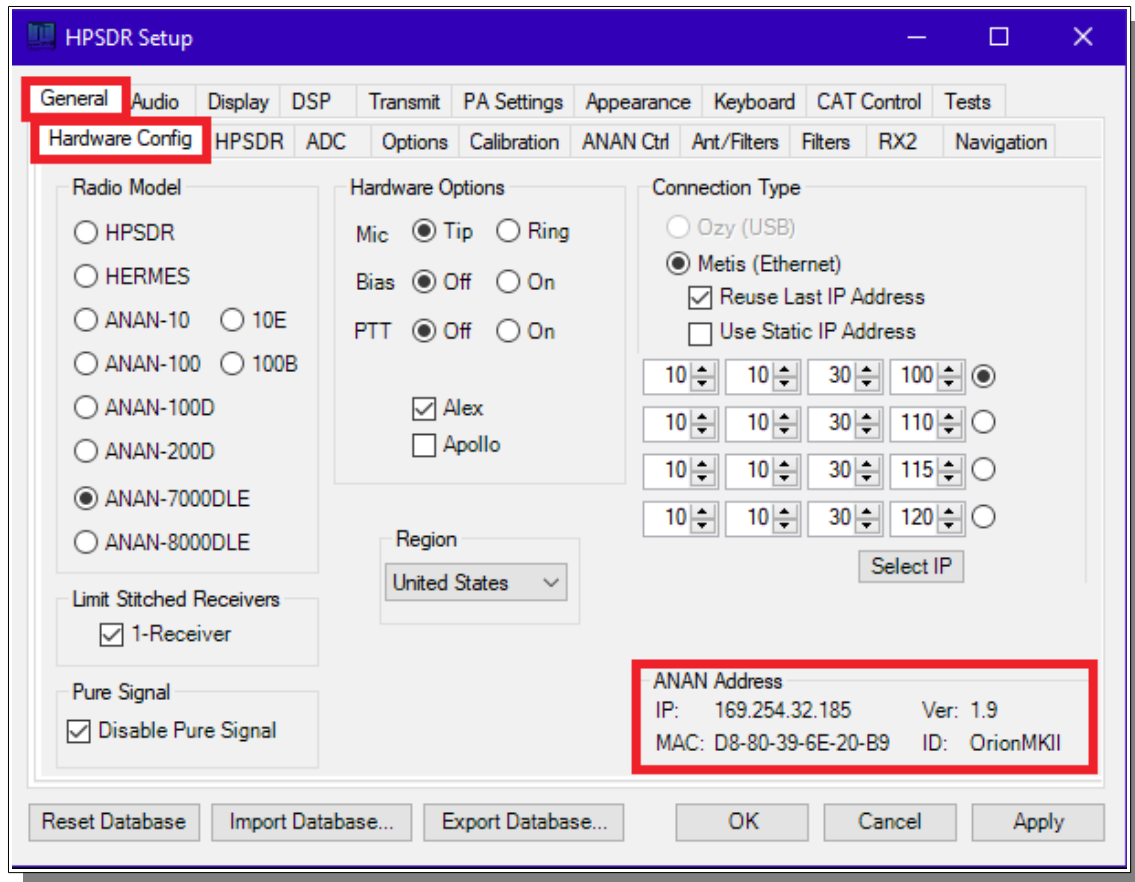

Go to → GENERAL → Hardware Configuration tab and note the **IP Address** and MAC address that are read from the radio's flash memory.

Note: if the IP ADDRESS is 0.0.0.0 then the software is **not** communicating with the Transceiver

- check your LAN connection.
- PowerSDR has not been started.
- Power button on the rig has not been activated.
- The RJ-45 LAN connector has two LED indicator lights. Check your LAN connector to insure that the **Link Light** on the **RIGHT** side of the LAN connector is illuminated. The **DATA Light** on the LEFT side of the LAN connector will blink as data is transferred to/from the PC.

## PowerSDR mRX PS IP address

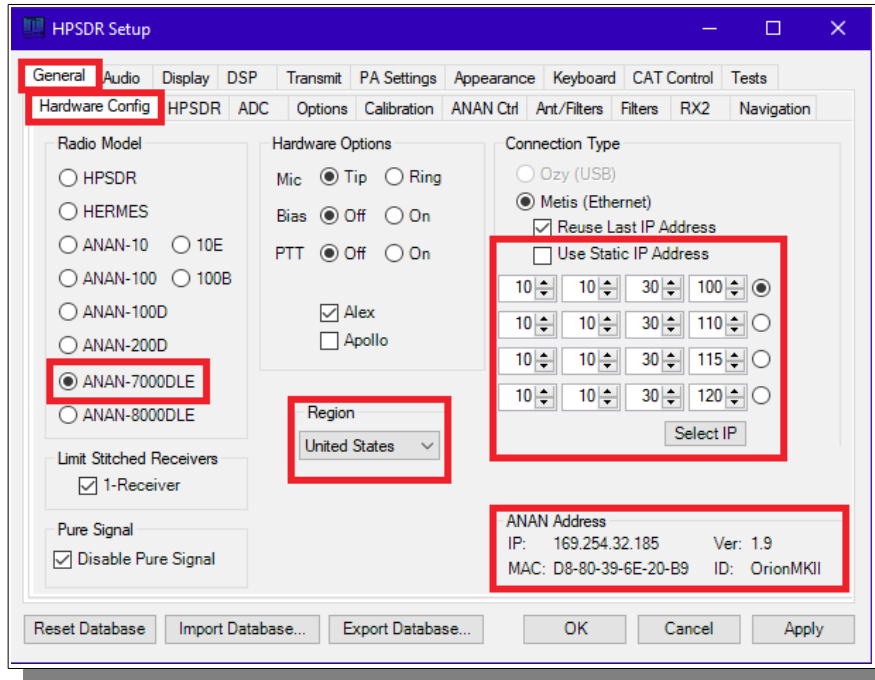

**Note:** Make sure you have selected the proper radio model from the selections on the LEFT side of the Hardware Configuration box. Failure to do so will result in an improper set of menu options and displays.

The Static IP Addresses are available to assign your instance of PowerSDR to a particular Apache Transceiver. There may be several Transceivers on your LAN and the Static IP address makes it convenient for assigning this software to a particular unit – where each unit has it's own IP address.

**Setup ---> General tab ---> Hardware Config** tab, the Radio Model should have ANAN-7000DLE selected. In the "**Region**", select the Country in which you reside.

The IP address and Firmware version number in the box highlighted above will be assigned automatically by your network router DHCP server, or if connected directly to your PC, the IP address will be assigned by the "**APIPA**" process – WHICH MAY TAKE UP TO SEVERAL MINUTES TO ASSIGN AN IP ADDRESS.

If your LAN is properly configured, the ANAN Transceiver board IP ADDRESS and MAC ADDRESS should be automatically detected and assigned. The correct default value is 169.254.1XX.XXX. PowerSDR will display the currently assigned IP address and MAC address of the ANAN Transceiver Hermes board if the LAN connection is properly connected and configured. If the ANAN Transceiver IP ADDRESS remains 0.0.0.0 then you must determine if PowerSDR and your PC network connection is operating correctly. Some typical problems could be that the Ethernet connection to your PC or LAN connector is disabled in Windows. The Ethernet connector may not be properly seated in your PC or Router. DHCP addressing must be properly enabled on your router. The new HPSDRProgrammer V2 utility allows you to assign a STATIC IP ADDRESS if you wish.

Please see the APIPA appendix of this document for more information.

## 4. SSB Phone Operation

### Connecting a suitable Microphone

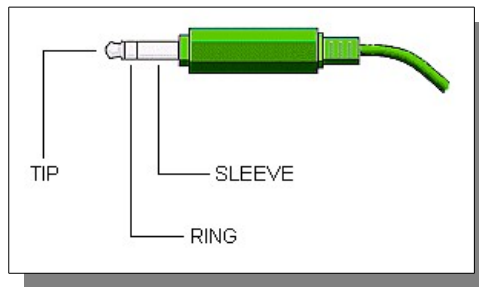

Most "Computer Condenser" microphones will work when directly plugged into the MIC connector on the front panel of the Apache Transceiver. The condenser mic requires a small bias voltage. You will need to enable the bias in the Setup Form. The **RING** is connected to the **push-to-talk** circuit and must remain disabled in software if a stereo mic is connected. The **SLEEVE** is connected to the Transceiver's analog ground. The **SPACE BAR** of your keyboard acts as the **default push-to-talk** for all microphones. A Computer Condenser mic without a push-to-talk switch can easily be used by substituting the **SPACE BAR of your KEYBOARD**.

Example: here is a link to a \$3 USD microphone using the keyboard space bar for push-to-talk:  
<http://www.officedepot.com/a/products/969486/Cyber-Acoustics-ACM-51-Boom-Microphone/>

PowerSDR mRX PS has a convenient Setup menu with individual selections for Tip and Ring settings.

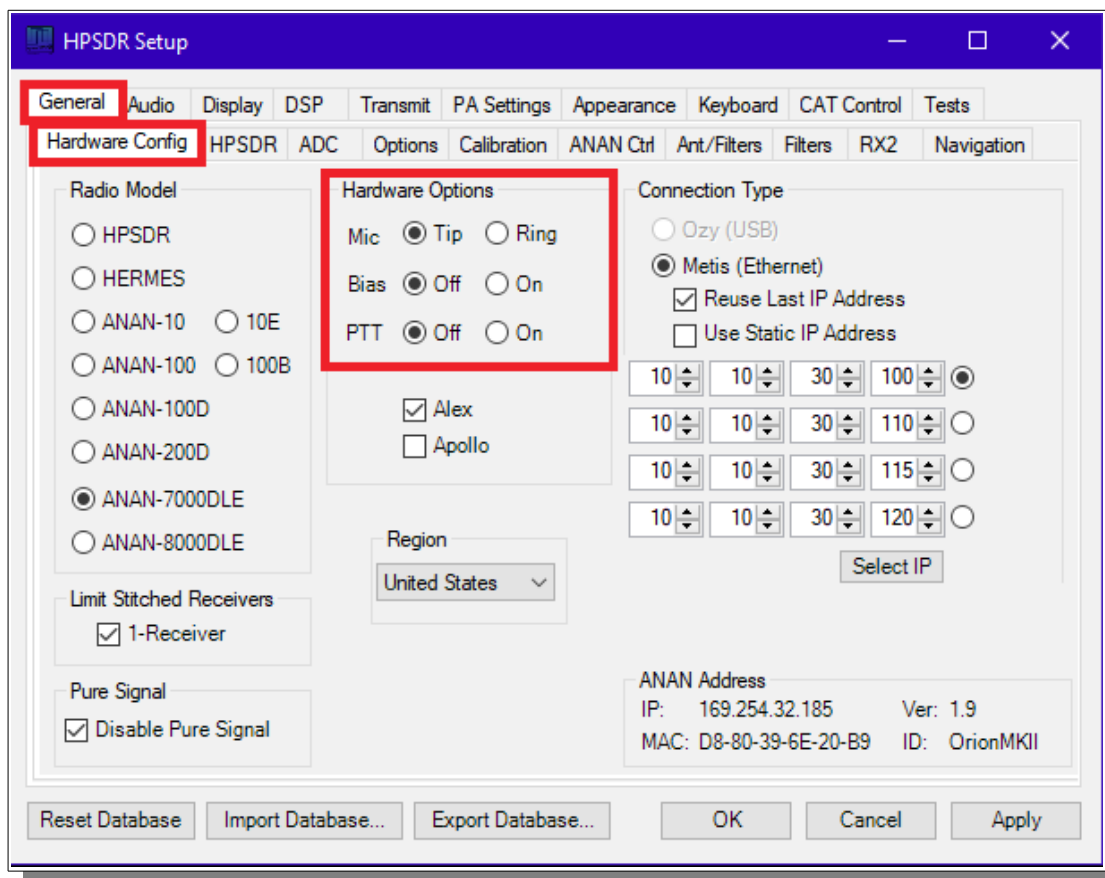

## MIC Adapters

- A Ham style, multi-pin microphone requires an adapter. Various adapters are readily available or can be configured for the Apache 1/8" or 1/4" Stereo style MIC socket.
- The Apache Labs Yahoo Group Files section has information about MIC connections and alternatives such as **Headsets** using a **Virtual Audio Cable** [VAC] utility or "**VB-Audio**".
- Microphone Connector Database  
<http://www.qsl.net/g4wpw/date.html>
- Yaesu to Apache adapter at Gigaparts

---

### Subject: [Apache-labs] PowerSDR\_mRX Audio Chain - How it works

From: Warren C. Pratt <[warren@wpratt.com](mailto:warren@wpratt.com)>

There has been quite a bit of discussion lately of MIC sensitivity and the audio processing in the mRX release. I think a few words of explanation about how things work might be helpful to those exploring various situations and alternatives.

In the case audio enters the MIC connector, it is fairly quickly routed to an audio CODEC to be converted to digital samples. Within that chip, before the ADC, there is a 20dB gain block that can be switched OFF/ON. This gain block is the 20dB Mic Boost that can be selected. Although I haven't tried, I suppose it's possible to overdrive the input stages or ADC [especially with the 20dB gain block enabled] which could result in clipping of the digital data and resulting distortion.

After conversion to digital, the 16-bit, 48Khz samples are transferred to the computer where they are promptly converted to floating point. With floating point samples, dynamic range is of little consequence as they then progress through the digital signal processing chain. The processing chain is then as follows:

**MIC GAIN** - a simple multiplier determined by your gain settings is applied to the samples.

**DOWNWARD EXPANDER** - If activated, the signal is reduced in gain if it is below the threshold set on the console.

**GRAPHIC EQUALIZER** - If activated, a filter is applied to the audio. The frequency response of the filter is tailored to the response curve that has been set.

**LEVELER** - If activated, the specified leveler gain is applied to the audio if/when the signal level is running below the leveler's output target amplitude. I currently have the output target set to +0.4 dB. Why not 0 dB? The slight positive bias is beneficial for upcoming features. [Note: NOT the same algorithm that Flex used.]

**COMPRESSOR** - If activated, the specified maximum compression is applied. Output is compressed to 0dB maximum. [NOTE: Not the compander algorithm that Flex used.]

**FILTER** - The audio is filtered to match the transmit bandwidth.

**ALC** - The audio is restricted to 0dB so as not to over-drive the fixed-point dynamic range of the FPGA and/or the DAC. [NOTE: Not the same algorithm used by Flex.]

Finally the audio is converted to 16-bit, 48Khz, samples and transferred to the hardware for up-conversion.

What happens if you run your MIC level above 0dB? If the Leveler is ON, you will get some compression and everything else runs as normal. If the Leveler is NOT ON but the compressor IS, you will get some additional compression above the value you have selected. If neither the Leveler or Compressor is ON, you will get some compression by the ALC. IN NO EVENT does the compression cause "flat-topping" or "splatter." This phenomena only results from non-linearity and overdrive of the analog amplifiers. Note that the ALC has no knowledge of the analog amplifiers--it is strictly in the digital signal processing chain.

73, Warren Prat NR0V



## Setting up PowerSDR for Phone Operation

With the rig powered on and PowerSDR software running, you should hear great audio from your speakers or headphones connected to the front panel "headphone" jack.

Select modulation mode of **USB** or **LSB** at the right and center of the console.

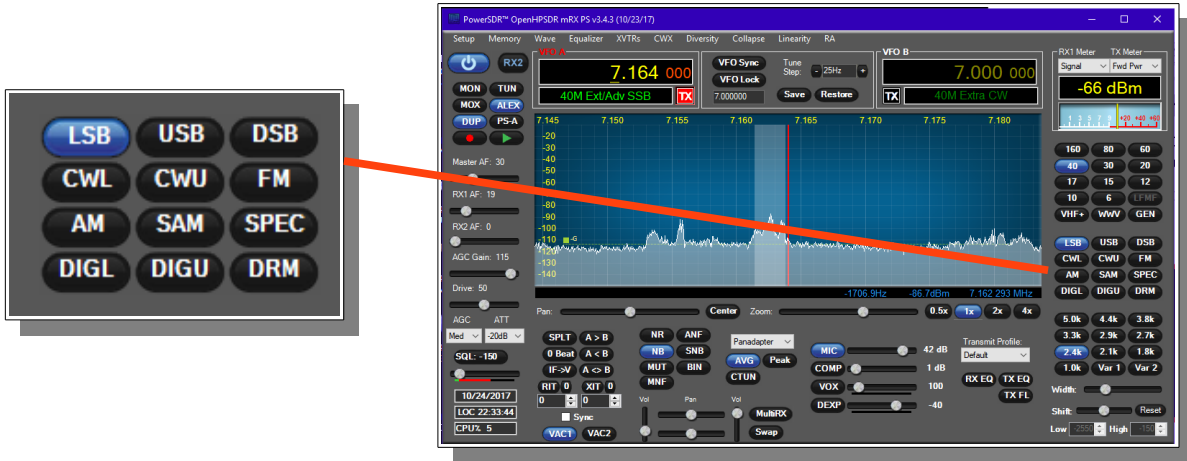

## Selecting Transmit Profile

The "Profiles" drop down menu allows you select various transmit profiles. The default profile is "Default". You can modify profile settings on this tab and save them to a profile name you select, or you can just modify the included profiles to your liking. You can recall saved profiles at a later time.

## Adjusting mic gain

You should make all microphone adjustments using a **Dummy Load** with proper PA Calibration.

Select Setup → Transmit, the default Source is "**Mic In**".

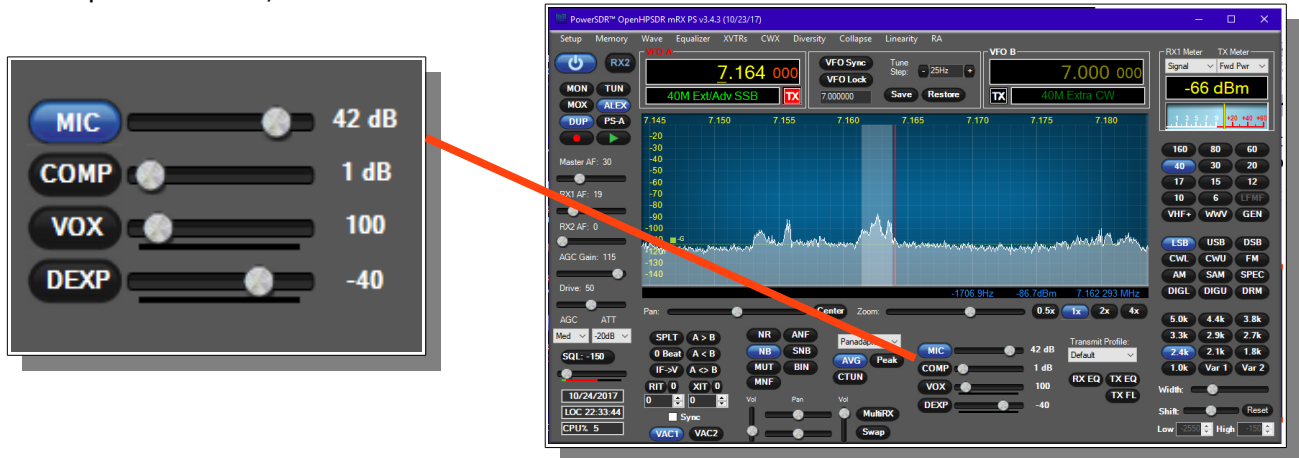

Locate the "MIC" gain control slider. It is located at lower right, below the panadapter. The present mic gain setting is shown just to the right of the MIC gain slider.

On the console, use the "TX meter" [Upper right corner] drop-down box to select "Mic".

Press your Mic PTT button, keyboard space bar, or click the "MOX" button on the console to key the radio. With the radio keyed and while speaking into the mic in a normal voice adjust mic gain for peaks 0db.

To enable or disable COMPRESSION click on the COMP button. We recommend that you set COMPRESSION to no more than 6dB.

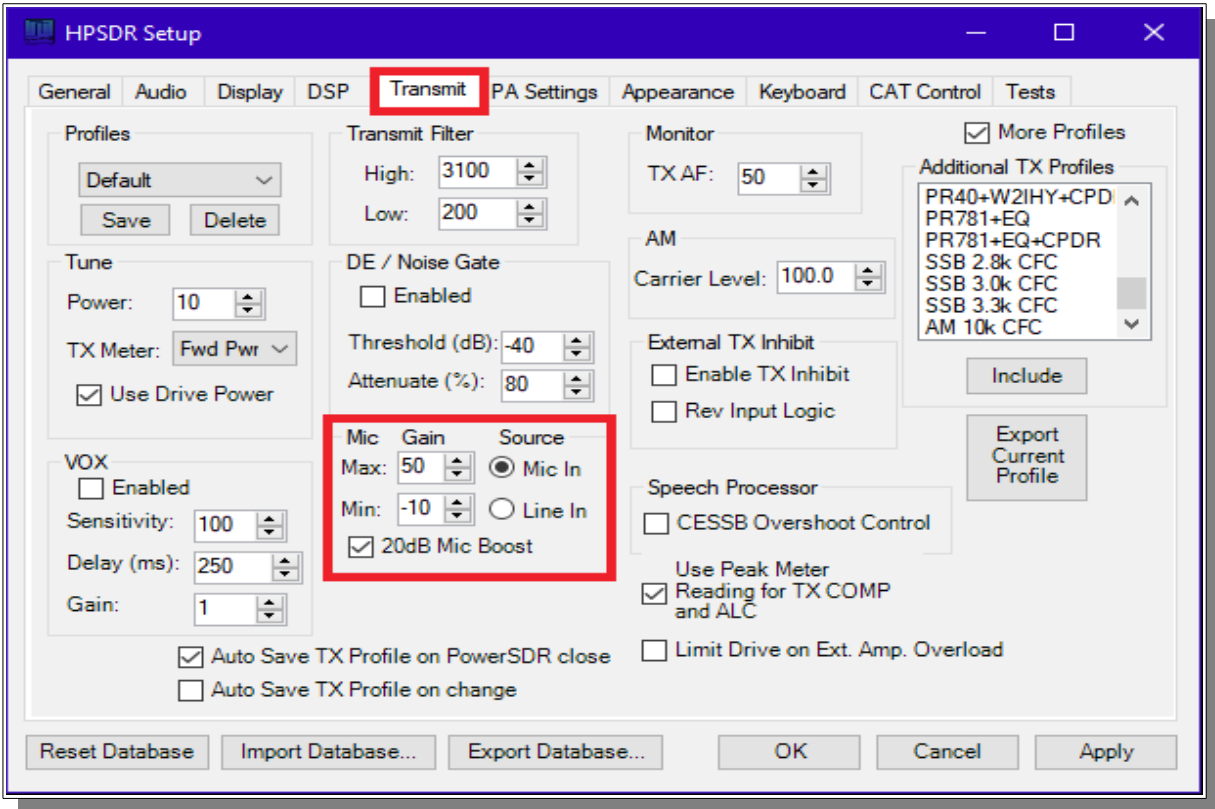

If 0 dB voice peaks cannot be achieved with the slider at the extreme right, go to the Setup, transmit tab [lower left], check **"20db Mic boost"** and readjust the "MIC" gain control on the console for 0 dB on voice peaks.

## Tune

The "Tune Power" spinner allows you to select the power output used when the "TUN" button is pressed on the console. This is actually a percentage of power output rather than output in Watts. The "TUN" button keys the transmitter using the specified power output level.

The "TX Meter:" drop down selects what the TX Meter on the console displays when the "TUN" button is pressed.

## VOX

Click the "enabled" button to enable "Voice Operating Transmit" if you want to cause the transmitter to key when you speak.

Set the sensitivity spinner to a higher value if you wish to have a higher voice level cause the transmitter to key.

Set the delay to cause the VOX to unkey the transmitter after not hearing voice for "Delay [ms]" milliseconds.

Use this with care. Local noises [dog barking, TV playing, door bell, computer sounds] can cause your transmitter to key when you do not want this to happen. Extreme cases can cause your transmitter to key for excessive periods of time resulting in damage to your radio and attached power amplifier.

## Transmit Filter

This filter tailors the transmitting frequency response in voice modes.

The default for high is 3100hz.

You can modify this and other values as needed before hitting the "Save" profile button to save for later recall.

## Antenna Control menu

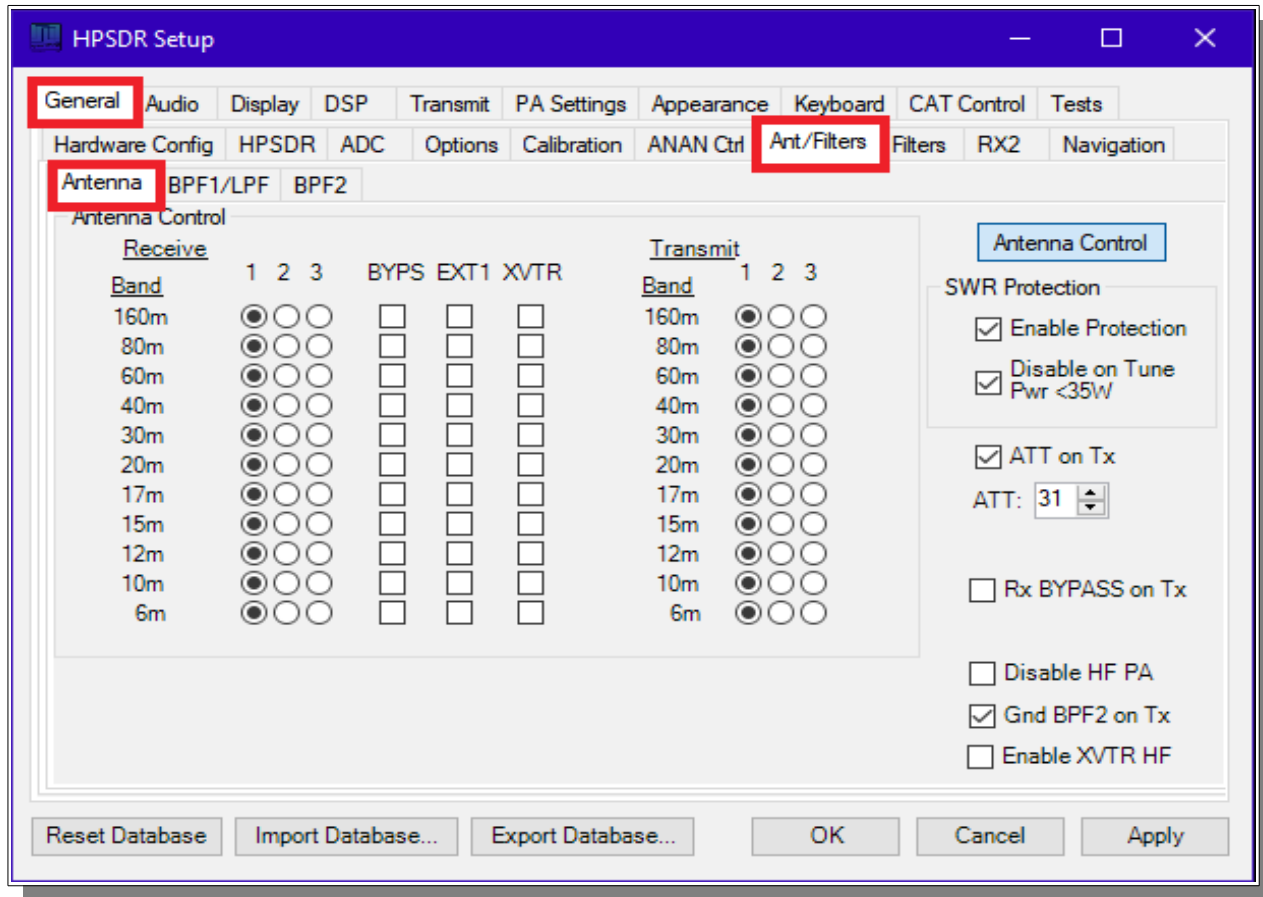

Separate receive and transmit antennas can be selected by use of the 1,2,3 radio buttons. This corresponds to the ANT1, ANT2, and ANT3 ports on the rear panel. Receive only antennas can be connected to the 'Rx BYPASS' or 'EXT1' ports on the rear panel. The 'Rx BYPASS' port does not have a BPF in the receive chain. The 'XVTR' port is for use with a transverter. When the box is checked the 'XVTR' port will only be switched when a VHF band is active.

**Enable Protection** will reduce power output when high SWR levels are detected above 2:1.

**Disable on Tune Pwr <35W** will disable SWR protection when the Tune power level is less than 35 watts. The Tune power level can be set on the Setup, Transmit tab.

**Rx BYPASS on Tx** option connects the 'Rx BYPASS' port to ADC1 during transmit. This can be used for connecting to an external coupler for PureSignal.

**ATT on TX** option inserts attenuation in the receiver chain when transmitting. This can prevent or reduce ADC overload warnings during transmit. PureSignal can adjust this setting automatically.

**Disable HF PA** disables the PA on HF bands. There is a separate Disable PA selection on the XVTR Form for use with a transverter.

**Gnd BPF2 on Tx** forces the input to ADC2/BPF2 to be grounded when transmitting.

**BPF1/LPF Filters Control menu**

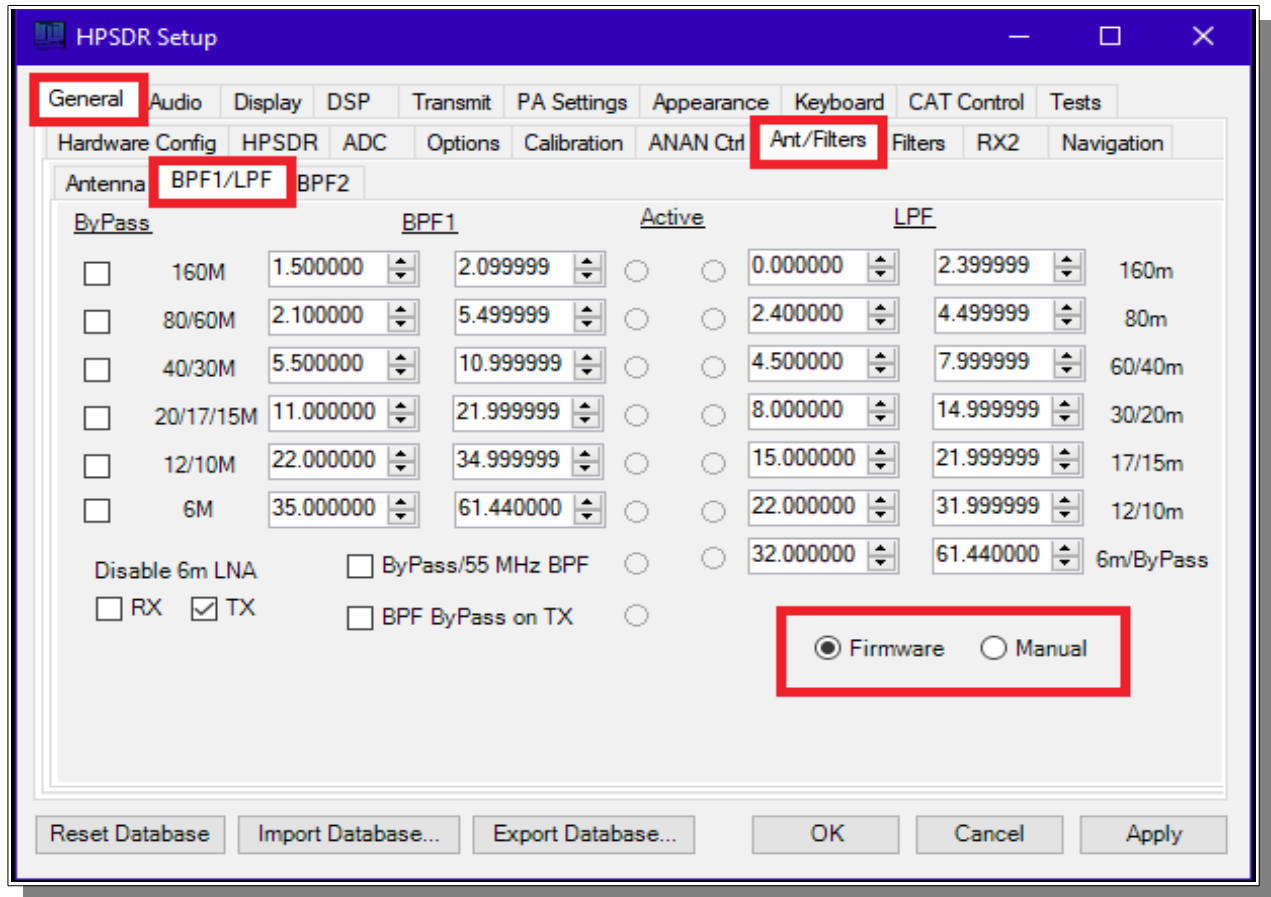

**When under firmware control the BPF and LPF are automatically selected as you change bands. Manual mode must be selected for any of these controls to function.**

Checking **ByPass** removes the band pass filter from the receive path for that particular band.

Values in the up/down boxes sets the frequency ranges.

**Disable 6m LNA** controls the 6 meter low noise amplifier preferences for receive and transmit. It is necessary to disable the 6m LNA when using PureSignal or performing two-tone tests on 6m. This is automatically done when under firmware control.

**ByPass/55mhz BPF** bypasses the band pass filters on all bands for receive and transmit.

**BPF ByPass on TX** will bypass the BPF during transmit on all bands.

The active buttons displayed between the BPF and LPF show which filters are currently active when in **Manual** mode.

The Firmware/Manual radio buttons should be left in **Firmware** mode for most operations. Selecting **Manual** will allow you to control which receive and transmit filters are selected as well as seeing which filter is in use.

## 5. CW Operation

### Sample Rate

Select a **SAMPLE RATE** best suited to your CW tuning style from the **Settings → AUDIO** menu

(although this shows the AUDIO menu, it is an historical reference to the original Flex SDR-1000™ which used Audio Sound Cards as the interface for Digital Signal Processing. In **all modern Apache Transceivers**, the architecture is digital with **Direct Down Conversion**. Sample Rates are handled by the high speed FPGA (Field Programmable Gate Array) chip inside the radio on the Transceiver board)

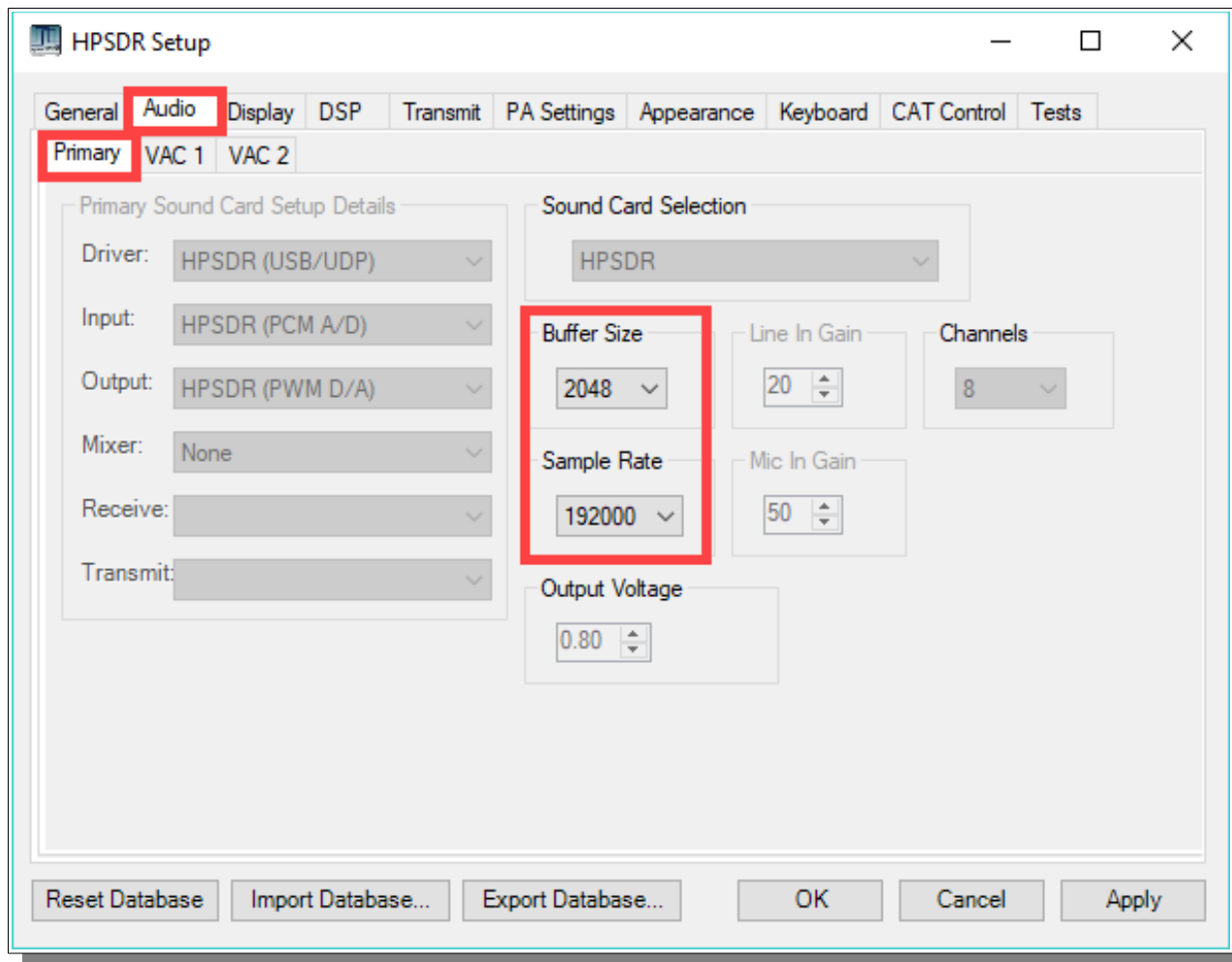

The appearance of the Panadapter can be adjusted with the **ZOOM** settings, **Sample Rate**, and **SETUP → DISPLAY → RX1 [or RX2] → Fast Fourier Transform Size [min to max] Bin width**.

## Iambic B

Select Iambic A or B from the **Settings** → **DSP** → **CW** menu

Note: Unchecking Iambic allows you to use the Paddle input in "Bug" mode or with a Straight Key connected to the DAH paddle input.

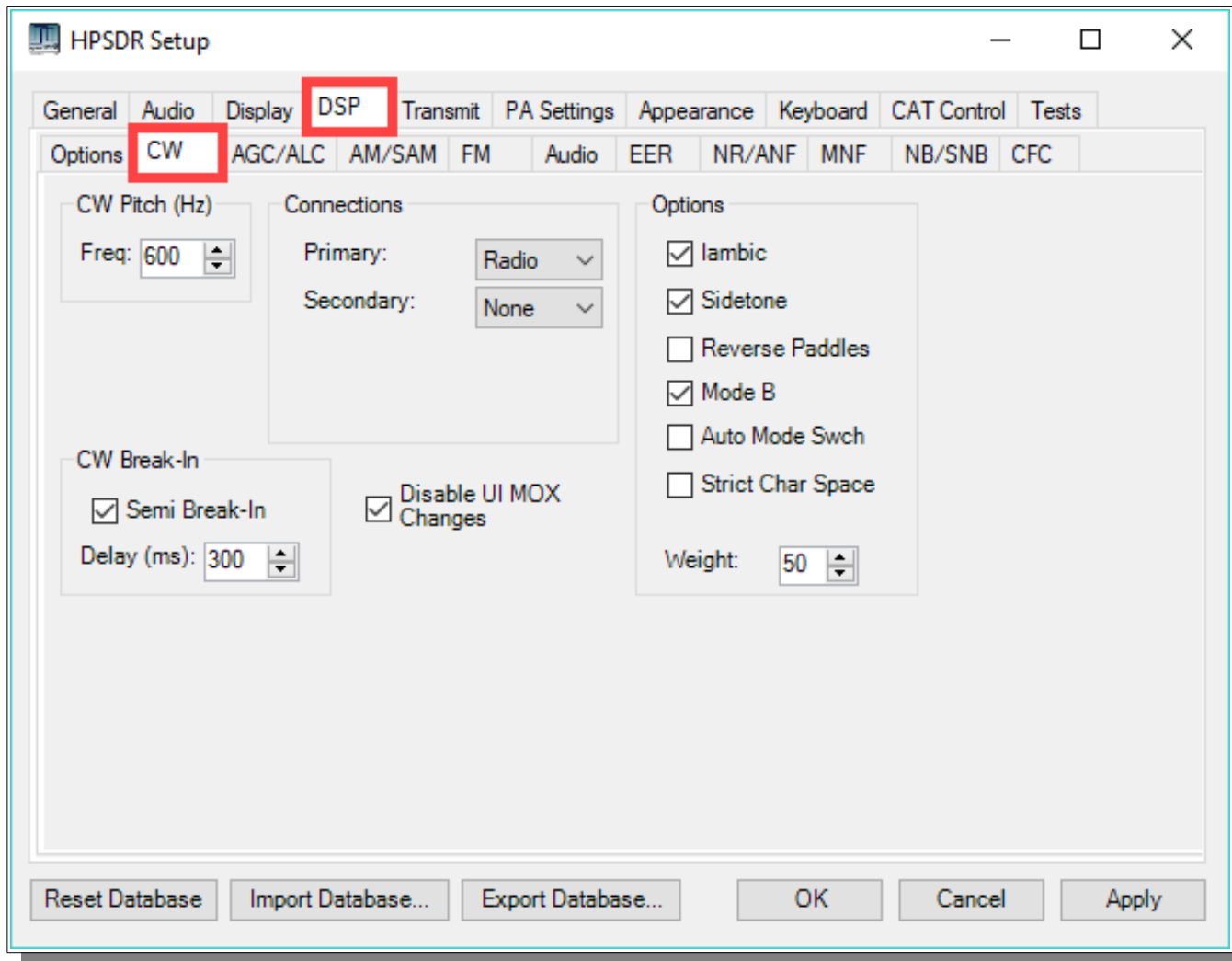

## CW Paddle Connection

Plug your favorite paddles into the front or back panel.

To use a CW key with PowerSDR you will need to enable it in the menu. To do so, click on **Setup** → **DSP** tab followed by the Keyer tab.

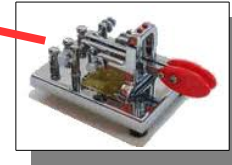
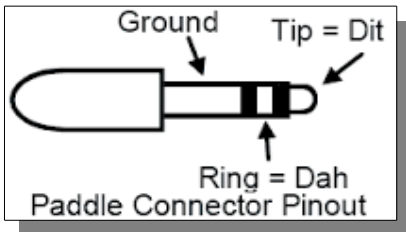

Provides connection for a CW key, either straight, single-paddle or Iambic. If using dual-paddle or Iambic mode, the common connection of the key should be made to the sleeve of a 3.5mm 1/8" stereo plug, the "dot" side to the ring and the "dash" side to the tip. If a straight key is used, this should be connected between the sleeve and the tip of the plug. PowerSDR Software enables the dot and dash connections to be reversed via a menu selection [above]. The dot and dash connections are connected to 3.3vdc via a 1k resistor.

If you find that your DAH and DIT **paddles** are **reversed**, there is a very convenient SETUP check box to put DAH on tip and DIT on Ring of the input PLUG

## CW/CWL

- Select **CWLower** or **CWUpper** from the **MODE** buttons on the console. Note the position of the filter changes.

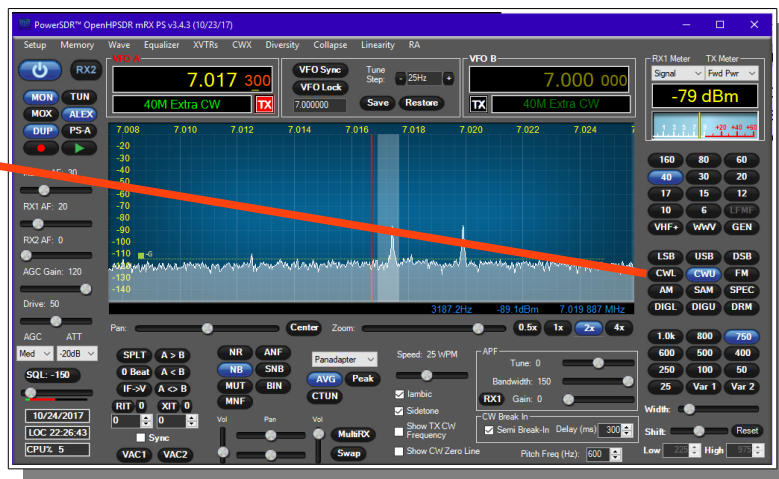

## Select Operating Frequency

- Using your mouse on the PANADAPTER display, **select your operating frequency.**

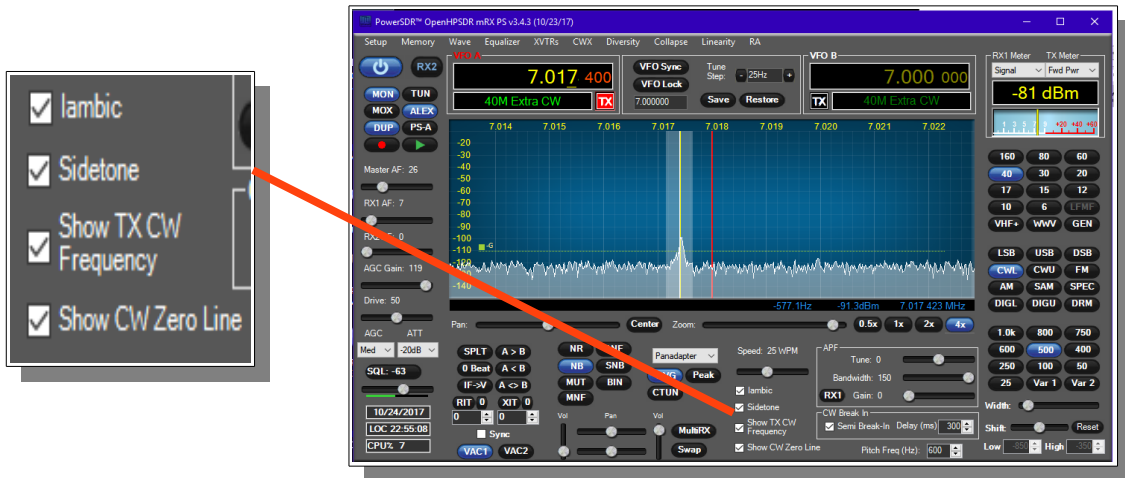

Note that you can see your **CW [BFO] CENTER FREQUENCY** or **TX FREQUENCY** by checking the boxes on the console. Those convenient vertical yellow marker-lines are really great when you are working split. The **SPEED** of the internal Iambic Keyer is shown at the top of this picture.

## Set Drive Level

- Set the DRIVE LEVEL** slider to 50% [mid range].

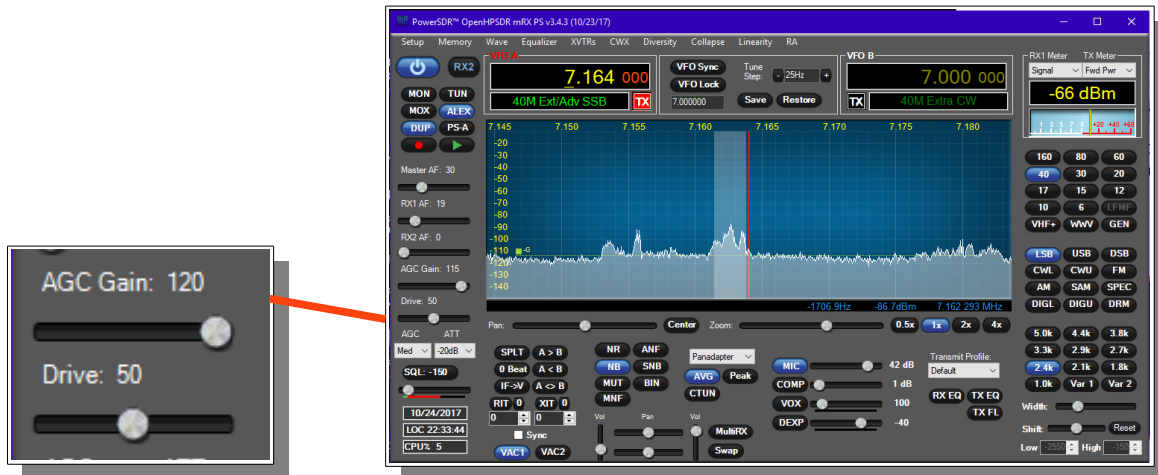



## Break-in Delay

You may wish to start with the default CW DELAY setting of 300ms. That value gives you plenty of time to complete words without tripping the T/R circuit at 20WPM. Set the DELAY to a value that best suits your comfortable operating speed.

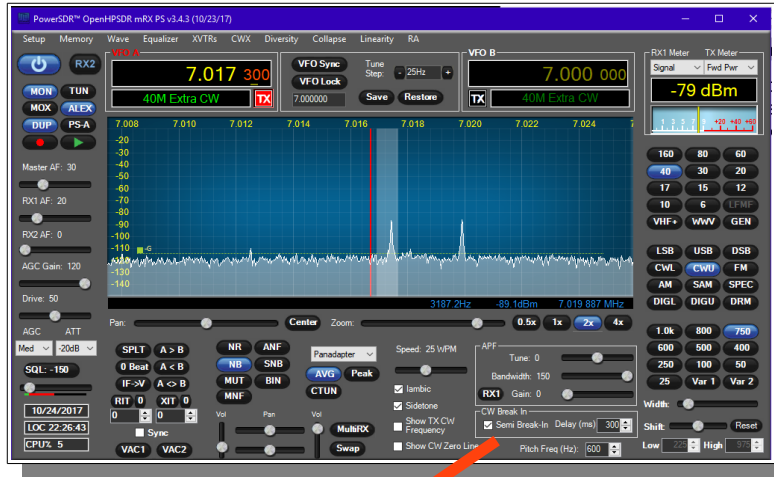

## Sidetone Level

Using a Dummy Load send some code and see if the **sidetone** is at a comfortable level. The **MASTER AF** slider

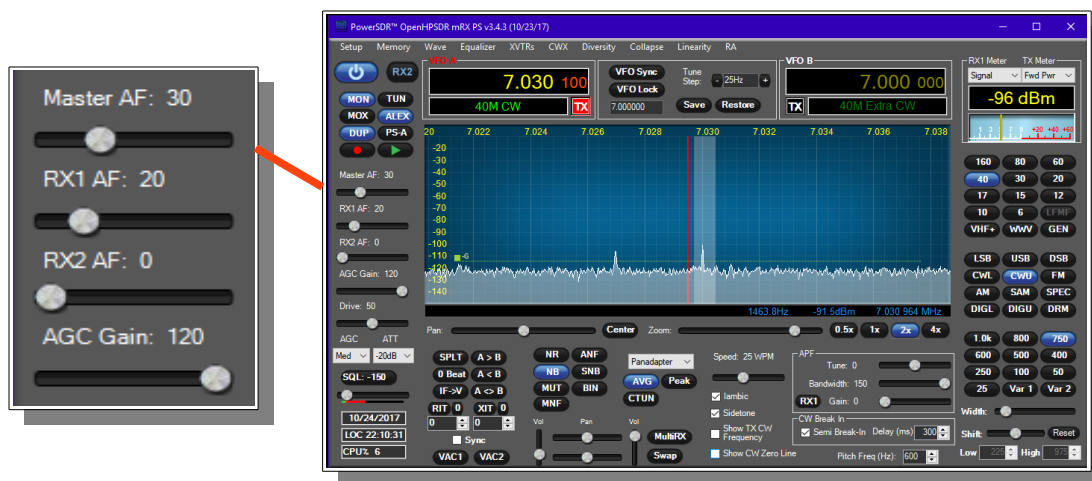

[upper left] is ALSO the MONITOR LEVEL setting when you are in **Transmit**.

## Tuning

### Tuning Methods

The ANAN-7000DLE ADC samples the entire spectrum from 0Hz through approximately 61.44 Mhz. The receivers are implemented in the FPGA where their data is decimated to an amount of spectrum suitable to send over Ethernet to your PC. If you have an antenna that will receive all those frequencies [like a vertical, loop, or dipole) you can tune your Rx1 and Rx2 to independent frequencies at the same time.

Rx1 might be on your Left speakers [or headphones) and Rx2 might be on the right speaker with easy front panel PowerSDR controls. The MultiRx feature offers a second receiver within the passband of the primary receiver. Rx2 will be undisturbed by the MultiRx and will continue to receive its independent band and frequency. Take note of the Multi and Rx2 controls in the console.

### Direct numeric input

**Keyboard commands** – see Setup → Keyboard menu

### Point and Click with Mouse

The mouse can be used to tune signals on the Waterfall or Panadapter. Select an active amateur band by clicking on one of the band buttons located just below the "S Meter" in the upper right portion of the PowerSDR window.

If you right click the mouse on the Panadapter you can go into "click tune" mode. The display will show a yellow indicator tuning line and filter width setting. Left clicking with the mouse will then QSY the receiver to that frequency. You can right click again to revert from "click tune" mode to "drag" tuning mode.

The "Zoom" slider and the "0.5x, 1x, 2x and 4x" buttons can be used to modify the frequency range displayed in the Panadapter. These controls are located just below the Panadapter/waterfall display. The "Pan" button can be used to move the displayed frequencies within the selected range.

### Drag Mouse

If you press and hold the left mouse button you can "drag" the frequency of interest into the panadapter highlighted filter area.

**Roll Mouse Wheel** – see console TUNE STEP selections

### CTUNE

The PowerSDR "CTUN" button enables "Click Tuning" while using the panadapter and waterfall displays. "Click tuning" when active, allows you to click within the Panadapter or waterfall to QSY without shifting the Panadapter or Waterfall display. When "CTUN" is inactive, clicking on the Panadapter re-centers the panadapter, thereby shifting the entire panadapter. Note that the "CTUN" function only works within a frequency range equal to the sample rate. IOW, if the selected sample rate is 384khz and RX1 panadapter is 1 MHz, wide, CTUN will only function within the center 384khz of the panadapter or waterfall display.

### DUP

**DUP** [DUPLEX] enables RX1 reception during transmit, allowing the user to view the transmitted RF signal in the Panadapter. Monitoring of the RF transmission using the **DUP** feature is visible in the Panadapter and Panafall modes.

**LOCK VFO** – prevents an unintended change of VFO frequency while in a QSO.

### Tune/SWR/Output

Select the **TUNE** button to see your **SWR** and **RF OUTPUT** power in the upper right corner of the console. Select various meter options to see which one suits your operating style.

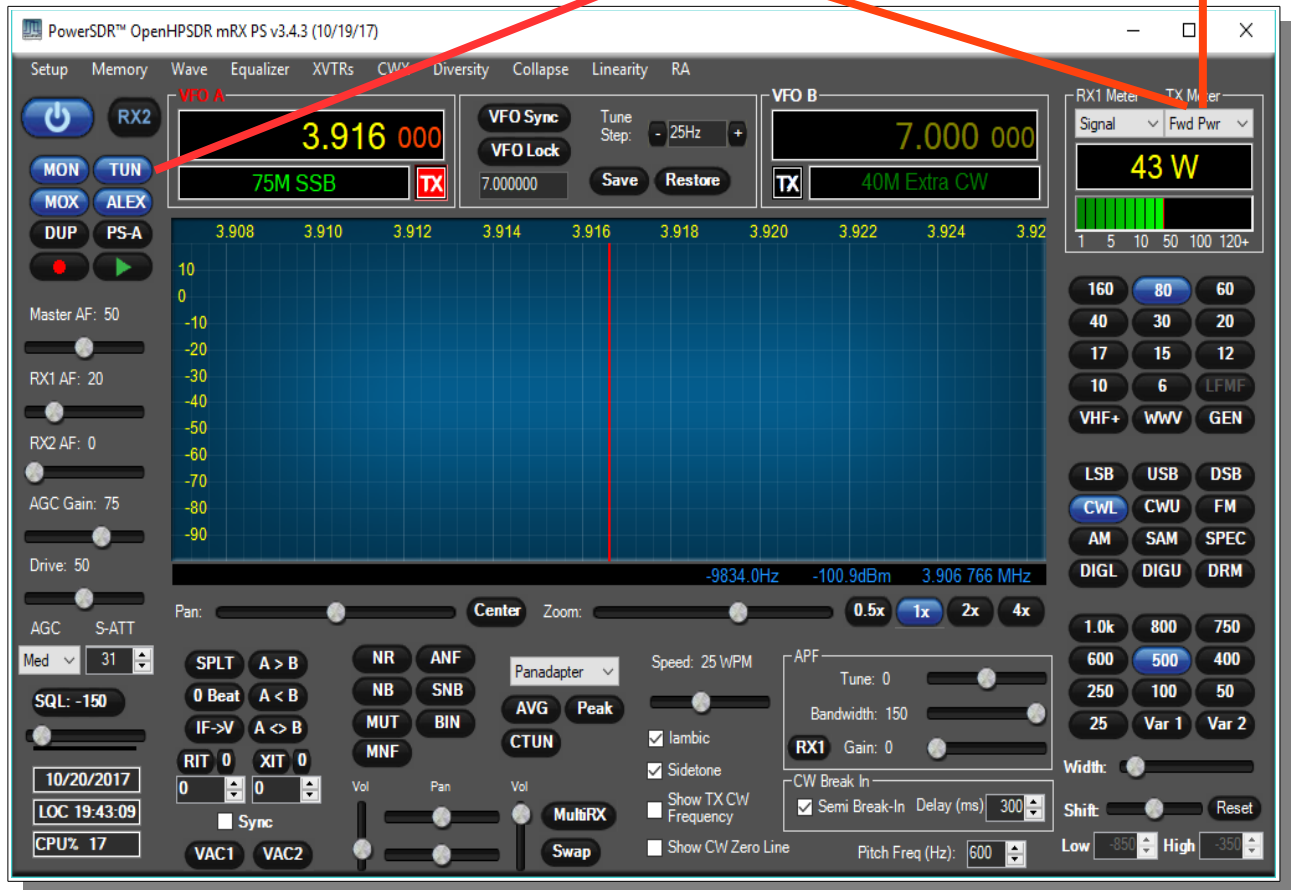
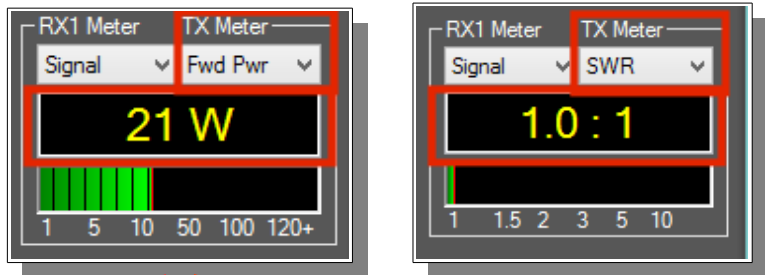

## 6. Linear Amplifier connection

### PTT Out

Most modern Linear Amplifiers have a connection for keying the amplifier. The radio includes a back panel RCA connection for this purpose.

The **PTT Out** feature is best used to switch **25vdc** and **1A**. Exceeding these values may damage the PTT OUTPUT circuit.

How to test your PTT Linear Amplifier circuit **BEFORE** connecting your Apache Transceiver.

- Power your Linear, connect the control cable to your linear but do **not** connect the other end to your Apache Transceiver
- Using a **DC Voltmeter**, measure the voltage between the center pin and the outer connection of the cable. This must be less than **25vdc**.
- Connect a **DC Ammeter** between the center pin and the exciter connection of the cable. This should **ACTIVATE** the Linear Amplifier and give you a clear measurement of the current requirements. The ANAN-7000DLE PTT circuit should **not draw more than 1A**.
- If either of these values are out of the required range, then use an external keying interface. There are many keying interfaces available from many sources such as MFJ, Elecraft, DX Engineering.

**Important:** Connecting a Linear Amplifier that does not meet the above voltage and current requirements is likely to cause damage to the Apache Transceiver linear switching transistor and extreme cases, serious damage to other parts. Damage to the radio caused in this manner is not covered by Warranty.

### Linear Amplifier Keying ISOLATION adapters

<http://www.dxengineering.com/search/product-line/kd9sv-products-sv-kr-keying-relays>

<http://www.ameritron.com/Product.php?productid=ARB-704>

<http://www.sultantronics.com/product.html>

### ALC

The 7000DLE does not offer ALC control for an external amplifier.

## OpenCollector BCD keying

Automatic Band Selection can be accomplished using the Open Collector Outputs available on the **OC DB-9F** connector on the back panel.

This is an example shows how to prepare Open Collector Outputs for BCD [binary coded decimal] for control of external devices [such as band information for a Hercules Linear Amplifier].

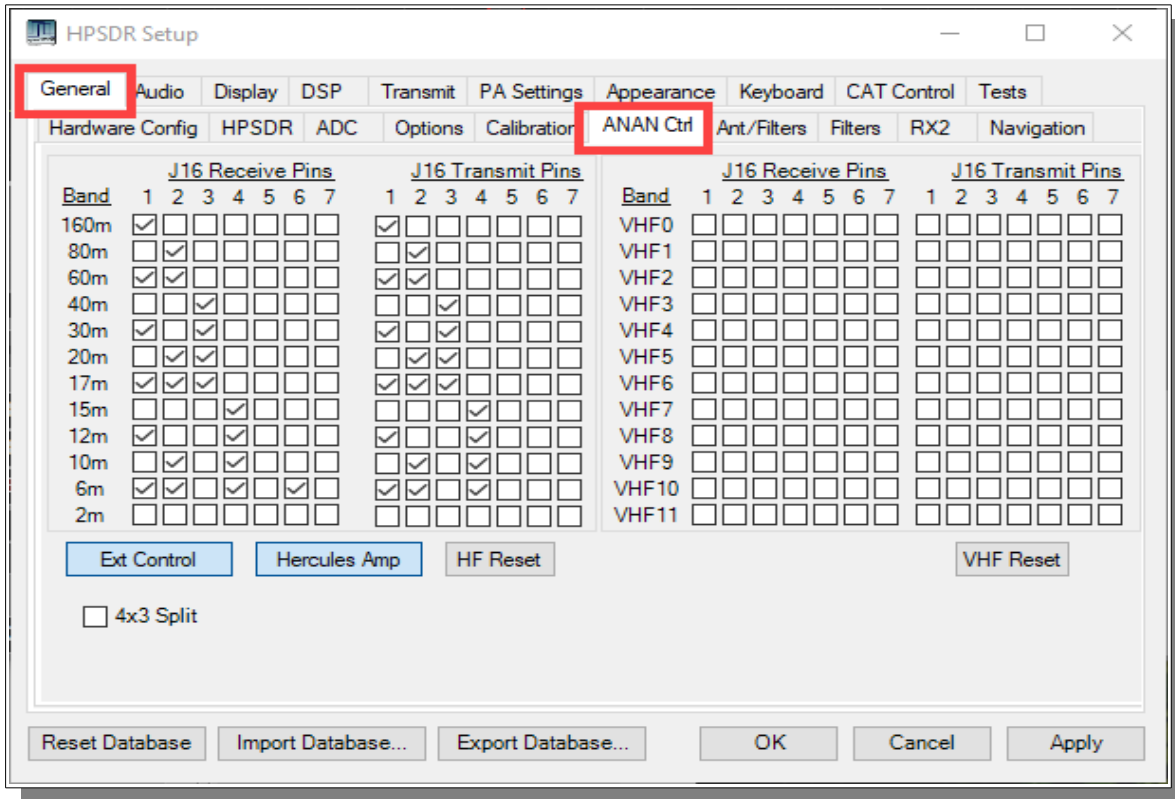

4x3 Split – When enabled the 7 OC outputs are split into 1x4 and 1x3. The first 4-bits are controlled by VFOA band data and the upper 3 are controlled by VFOB band data.

## 7. Transverter

### XVTR T/R port

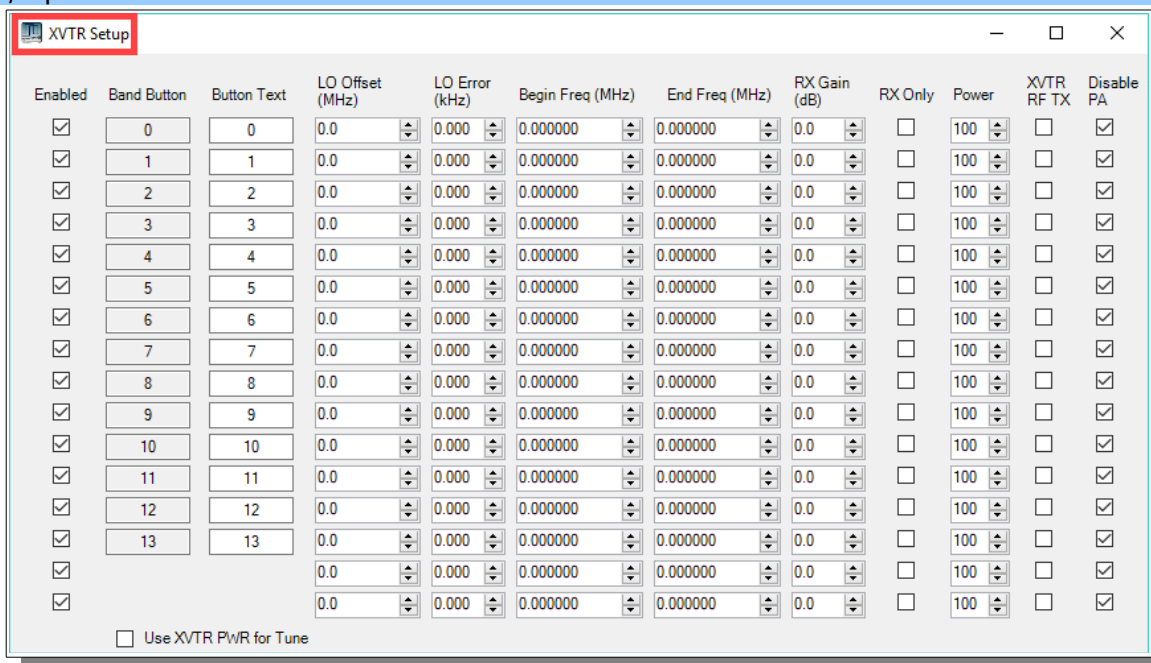

Enabled	Band Button	Button Text	LO Offset (MHz)	LO Error (kHz)	Begin Freq (MHz)	End Freq (MHz)	RX Gain (dB)	RX Only	Power	XVTR RF TX	Disable PA
<input checked="" type="checkbox"/>	0	0	0.0	0.000	0.000000	0.000000	0.0	<input type="checkbox"/>	100	<input type="checkbox"/>	<input checked="" type="checkbox"/>
<input checked="" type="checkbox"/>	1	1	0.0	0.000	0.000000	0.000000	0.0	<input type="checkbox"/>	100	<input type="checkbox"/>	<input checked="" type="checkbox"/>
<input checked="" type="checkbox"/>	2	2	0.0	0.000	0.000000	0.000000	0.0	<input type="checkbox"/>	100	<input type="checkbox"/>	<input checked="" type="checkbox"/>
<input checked="" type="checkbox"/>	3	3	0.0	0.000	0.000000	0.000000	0.0	<input type="checkbox"/>	100	<input type="checkbox"/>	<input checked="" type="checkbox"/>
<input checked="" type="checkbox"/>	4	4	0.0	0.000	0.000000	0.000000	0.0	<input type="checkbox"/>	100	<input type="checkbox"/>	<input checked="" type="checkbox"/>
<input checked="" type="checkbox"/>	5	5	0.0	0.000	0.000000	0.000000	0.0	<input type="checkbox"/>	100	<input type="checkbox"/>	<input checked="" type="checkbox"/>
<input checked="" type="checkbox"/>	6	6	0.0	0.000	0.000000	0.000000	0.0	<input type="checkbox"/>	100	<input type="checkbox"/>	<input checked="" type="checkbox"/>
<input checked="" type="checkbox"/>	7	7	0.0	0.000	0.000000	0.000000	0.0	<input type="checkbox"/>	100	<input type="checkbox"/>	<input checked="" type="checkbox"/>
<input checked="" type="checkbox"/>	8	8	0.0	0.000	0.000000	0.000000	0.0	<input type="checkbox"/>	100	<input type="checkbox"/>	<input checked="" type="checkbox"/>
<input checked="" type="checkbox"/>	9	9	0.0	0.000	0.000000	0.000000	0.0	<input type="checkbox"/>	100	<input type="checkbox"/>	<input checked="" type="checkbox"/>
<input checked="" type="checkbox"/>	10	10	0.0	0.000	0.000000	0.000000	0.0	<input type="checkbox"/>	100	<input type="checkbox"/>	<input checked="" type="checkbox"/>
<input checked="" type="checkbox"/>	11	11	0.0	0.000	0.000000	0.000000	0.0	<input type="checkbox"/>	100	<input type="checkbox"/>	<input checked="" type="checkbox"/>
<input checked="" type="checkbox"/>	12	12	0.0	0.000	0.000000	0.000000	0.0	<input type="checkbox"/>	100	<input type="checkbox"/>	<input checked="" type="checkbox"/>
<input checked="" type="checkbox"/>	13	13	0.0	0.000	0.000000	0.000000	0.0	<input type="checkbox"/>	100	<input type="checkbox"/>	<input checked="" type="checkbox"/>
<input checked="" type="checkbox"/>			0.0	0.000	0.000000	0.000000	0.0	<input type="checkbox"/>	100	<input type="checkbox"/>	<input checked="" type="checkbox"/>
<input checked="" type="checkbox"/>			0.0	0.000	0.000000	0.000000	0.0	<input type="checkbox"/>	100	<input type="checkbox"/>	<input checked="" type="checkbox"/>

Use XVTR PWR for Tune

The XVTR (transverter) Setup Form allows the user to configure up to 14 external transverters.

- **Enabled:** Enables a particular Band Button on PowerSDR with the options selected.
- **Band Button:** Band button to use for the particular transverter that is being configured.
- **Button Text:** The text that will be shown on the Band Button.
- **LO Offset (MHz):** The difference between the transverter low frequency and the IF frequency. For example, on 2m, you might use 144-28 MHz = 116.
- **LO Error (kHz):** This setting allows the user to correct for any error in the transverter's oscillator.
- **Begin Frequency (MHz):** The lower frequency bound for the transverter.
- **End Frequency (MHz):** The upper frequency bound for the transverter.
- **RX Gain (dB):** Amount of gain to apply to the incoming signals to compensate for gain within the transverter. Please note that this is still in development.
- **RX Only:** If this box is checked, the radio will not transmit while in this configured band.
- **Power:** Sets the Drive control on PowerSDR to this value whenever the VFO is within the configured band.
- **XVTR RF TX:**
- **Disable PA:** Disables the internal 100W Power Amplifier. Low level RF is sent via the XVTR TX SMA connector on back panel.
- **The user must make careful adjustments using the PA Gain By Band using the VHFxx spinners and the Drive level to insure the transverter sees the proper level.** With the PA Gain by Band spinners set to their default value of 65.0 and the **Drive** slider to 100 the RF output is approximately 10mW at the XVTR RF SMA connector.



## 8. PureSignal Adaptive pre-distortion information

### PureSignal Predisortion

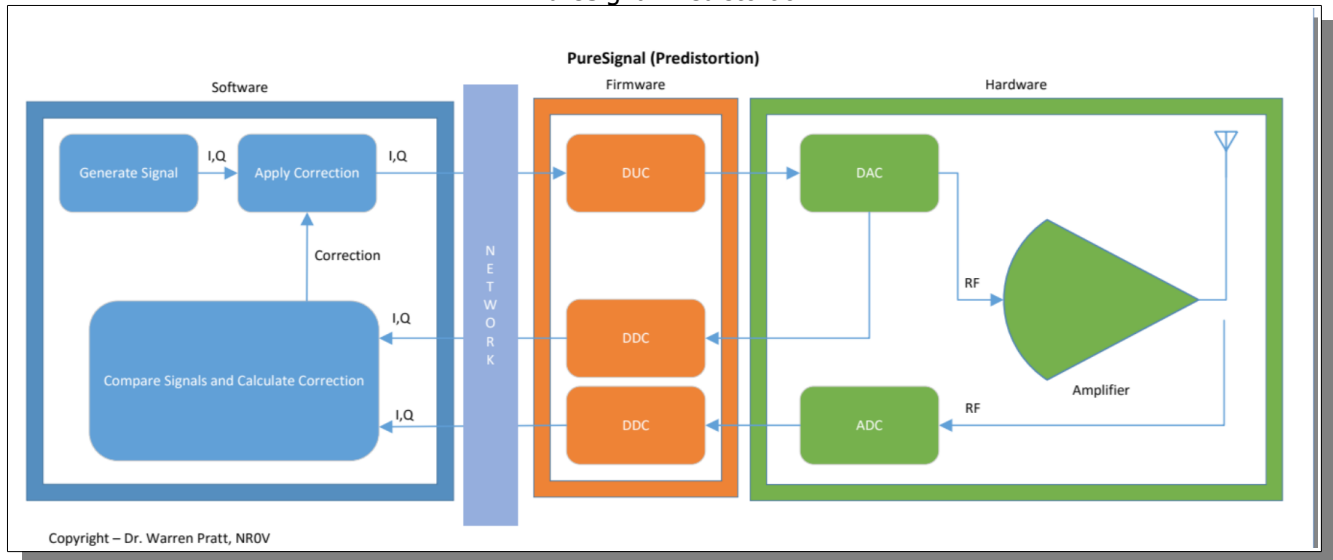

### PureSignal document repository

Linearity of an amplifier implies that the output increases linearly with increases of the input signal. i.e., if an input of 5W produces an output of 50W, then an input of 10W should produce an output of 100W.

Unfortunately, the analog amplifiers in our power amplifier stages are not so perfect. A real amplifier might behave more like the figure below.

The unfortunate side-effect of this NON-linearity is Inter-Modulation Distortion [IMD], some of which results in "splatter." Consequently, on the Panadapters of our SDRs it's easy to see signals that extend outside a normal transmit bandwidth. This phenomenon is more evident on strong signals as the IMD may be 25dB or more down from the peak of the signal. This IMD pollutes our bands and raises the interference and noise levels for amateurs that may be operating many kilohertz away from the offending transmitters. Some of the IMD is less visible on Panadapters because it falls IN-BAND, i.e., within the bandwidth of the transmitted signal. This adds distortion to the signal.

Fortunately, several techniques have been developed to improve the linearity of analog amplifiers and thereby reduce the IMD levels that they generate. One such method is "Predisortion"—making the amplifier's output more linear by "predisorting" the input signal in such a way as to offset the distortion that the amplifier will produce. The output of the amplifier can therefore be corrected to behave very much like the ideal case shown above.

**Editorial note:** IMD robs you of the value of an expensive Linear Amplifier by needlessly pumping out bad Energy in opposite sideband and IMD splatter.

## Using PureSignal Adaptive Predisortion

Enable PureSignal using the **PS-A** button. Select **Linearity** from the menu to configure.

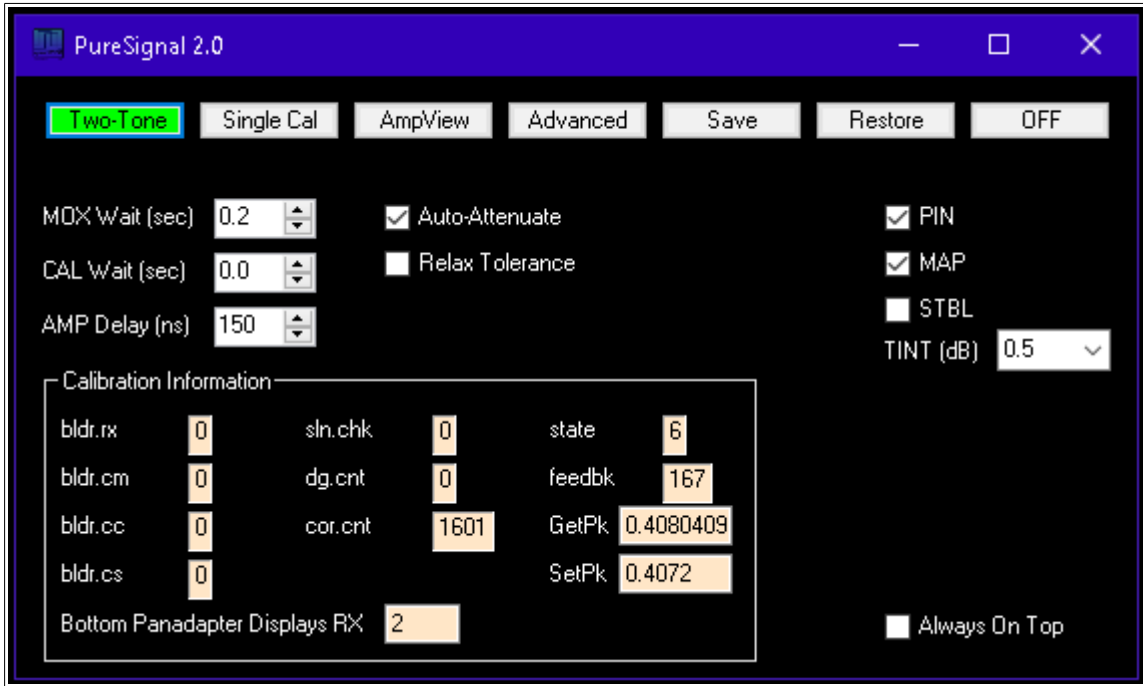
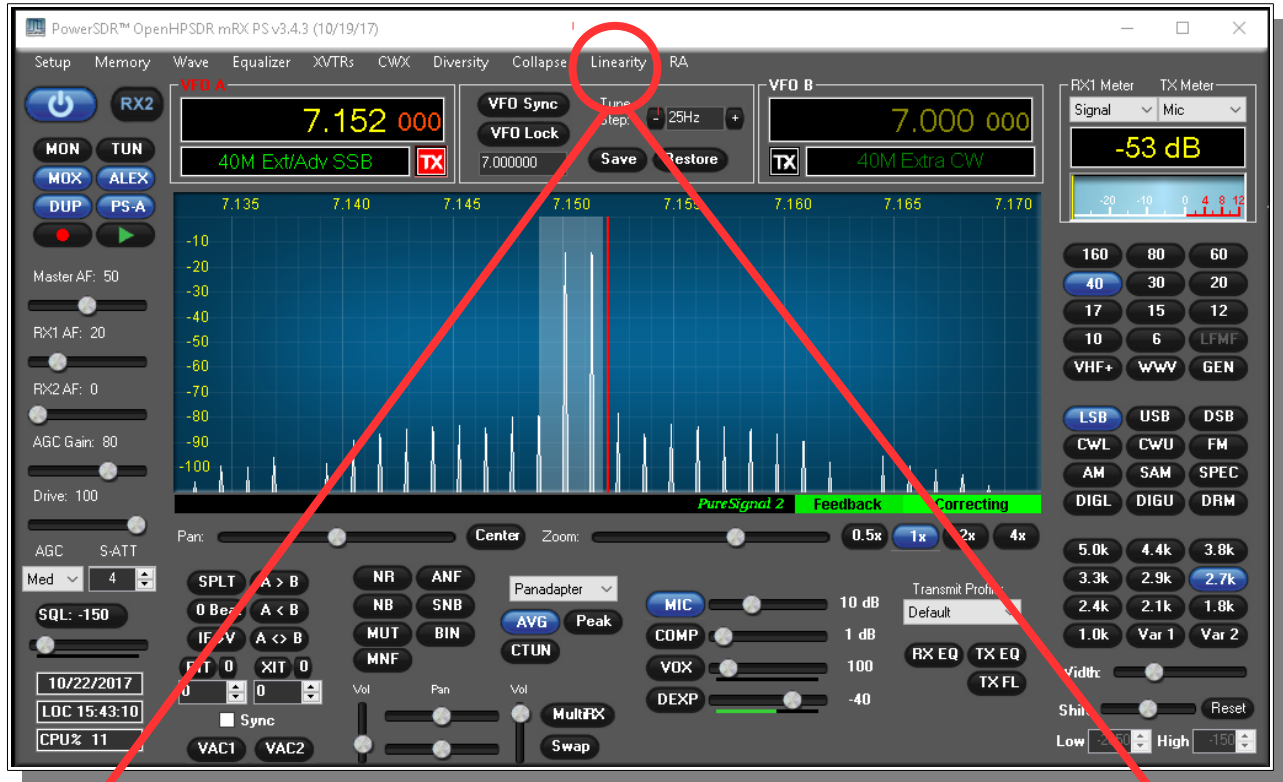

Using a **DUMMY LOAD** and your **Panadapter set for DUP**, you can activate the **TWO TONE** button in the PureSignal Control Window. You should immediately see your transmitted signal displayed with the primary and odd harmonic peaks. PureSignal will adjust your ATT on Tx for an optimal value and then in just a few seconds it will lower your 3<sup>rd</sup>, 5<sup>th</sup>, 7<sup>th</sup> Intermodulation Distortion Product peaks to a surprisingly lower level. PureSignal can optimally adjust unwanted IMD by as much as -45dbc or more depending on your particular configuration. PureSignal will continue to optimize your signal as you speak in a normal voice.



## SIGNAL PROCESSING

In the 'Advanced' controls section, the 'Calibration Information' panel is visible, and, there are four new controls that were not in PureSignal 1.0. These new controls represent new functionality that has been added and they should normally be left at their default settings. The controls are:

\*\* **'PIN'**: Applies *a priori* knowledge of the required amplifier gain and phase correction in situations where the collected samples are insufficient for optimal calibration. This need can arise when the radio is not being properly driven to allow sample collection over the entire operating range, or due to some other fault or incorrect operation. This is very useful when there is a significant voltage regulation problem in an amplifier and, therefore, the gain and phase of the amplifier appear somewhat "unstable" as PureSignal collects feedback for calibration.

\*\* **'MAP'**: Changes the sample-collection requirements to allow easier calibration in situations where the amplifier is detected to be in heavy gain compression. This is done by mapping the collection intervals to a different set of intervals based upon the level of compression. Note that this relaxation in sample-collection requirements MIGHT cause some degradation in high-order IMD. This is adaptive; the extent of the remapping depends upon the level of compression. If there is no compression, this function has no effect.

\*\* **'STBL'**: Substantially separates the "static non-linearity" of the amplifier from the memory effects before computing the correction. This is a step toward further work on memory effects in a future release. When this is enabled, the "blue" and "yellow" displays on AmpView will show the extracted static non-linearity.

\*\* **'TINT'**: A largely experimental feature allowing selection of the size of the upper interval within which samples are required to be collected. The dB value reflects the reduction from full-scale. For example, 2.5dB means ~75% of full-scale voltage or ~56% of full-scale power. This should normally be left at the default setting of 0.5dB (~94% of full-scale voltage and ~88% of full-scale power). This feature can be useful in situations where an external processing system, for example a Digital Audio Workstation, is used to precisely control the audio drive amplitude. Note, however, that Auto-Attenuate should probably be disabled when not driving to full-scale as there may not be enough information to accurately calculate its setting which can result in instability in the attenuator value.

**NOTE ON AMPLIFIER GAIN COMPRESSION AND TUNING**. For modes requiring linear amplification, it is NOT recommended to drive amplifiers into heavy gain compression or "flat-topping." Doing so will increase IMD significantly when PureSignal is NOT active and may increase it slightly when PureSignal is active, due to heavy reliance on the MAP function. Driving into heavy compression will not increase your peak output power by any meaningful amount and, when using PureSignal, it will not increase your average power at all since PureSignal will remove the compression in the output signal to restore linearity. For vacuum-tube amplifiers with 'Tune' and 'Load' controls, if your amplifier has excess power capability compared to your desired output level, you can generally avoid heavy gain compression by tuning the amplifier for a higher power level than your desired output and then backing down the drive level to achieve the desired output. The down-side of this tuning approach may be a slight reduction in amplifier efficiency. It should be noted that there are "proper" ways to increase your average transmit power; those include the use of the Compressor and the CESSB Overshoot Control algorithm.

## **USER INTERFACE**

PureSignal Auto-Calibrate mode can now be used without opening the "Linearity" window. Simply click the "PS-A" button in the upper-left region of the console to activate PureSignal Auto-Calibrate. The "PS-A" setting will also be remembered in the database.

Indicators for Auto-Calibrate functionality will appear immediately below the panadapter display area, on the right side. "PureSignal 2.0", when displayed in green, indicates this functionality is active. Immediately to the right of that, the "Feedback" indicator will flash each time there is a new automatic calibration and the "Correcting" indicator will light when correction is being applied. Note that the color-scheme of the PureSignal items will not follow the color scheme of the other below-panadapter information. This is because, for PureSignal, color is used to indicate the status of the various items:

OFF/ON - Blue (Auto-Calibrate OFF), Green (Auto-Calibrate ON)

Feedback Level - Red (too low), Yellow (marginally low), Green (just right), Blue (too high)

Correcting - Green (correcting), Yellow (attempting correction but with marginal feedback level), Black (no correction being applied)

Note that the "PS-A" button is dominant over the "Disable PureSignal" check-box in Setup. In other words, if you click "PS-A" to turn-on Auto-Calibrate, if "Disable PureSignal" was checked, it will become Unchecked. While "PS-A" is active, you will NOT be able to check "Disable PureSignal".

The "Linearity" window has been stream-lined. You can click "Advanced" to expand the window to show the advanced signal processing controls and indicators; however, it is expected that the typical operator will leave settings at defaults and has no need to open this section. The width of the "Linearity" window has been expanded to match the width of the "AmpView" window, making it easier to stack the two on the screen.

**Dr. Warren Pratt NR0V**



## Reference materials

### Apache Labs Web Forum

The Apache Labs Web Forum is the central discussion point and main repository of knowledge for the Apache Labs user community [Apache Labs Community Forum](#)

### Nige G7CNF

Please be sure to look at the excellent YouTube video produced by Nige G7CNF. If you subscribe to his Channel, you will find specific information about PureSignal, Diversity Reception, Audio chain setup and many other Apache Transceiver topics. [Nige G7CNF YouTube Video](#)

### Apache Labs International Support

Technical support for ANAN-7000DLE from the factory is available via the Apache Labs Yahoo Group

<http://groups.yahoo.com/group/apache-labs/>

or directly via email <[support@apache-labs.com](mailto:support@apache-labs.com)>

### Apache Yahoo Support Group

<http://groups.yahoo.com/group/apache-labs/>

### OpenHPSDR Group

Instructions relating to joining the OpenHPSDR Group reflector are here:

[OpenHPSDR Email Archive](#)

The OpenHPSDR archives may also be searched here:

[OpenHPSDR Organization](#)

### Apache Service and Repair

1023 Tower B4, Spaze I-Tech Park

26, Sector-6, IMT Manesar

Gurgaon - 122050

Haryana, India

Tel: 91-0124-4245173/4/5 [10AM - 6PM IST]

IMPORTANT: Please email us at [support@apache-labs.com](mailto:support@apache-labs.com) for an RMA before arranging to ship a radio for repair to our US/EU or Indian Service Centers.

Website: <http://www.apache-labs.com>

## Manual Calibration Procedure

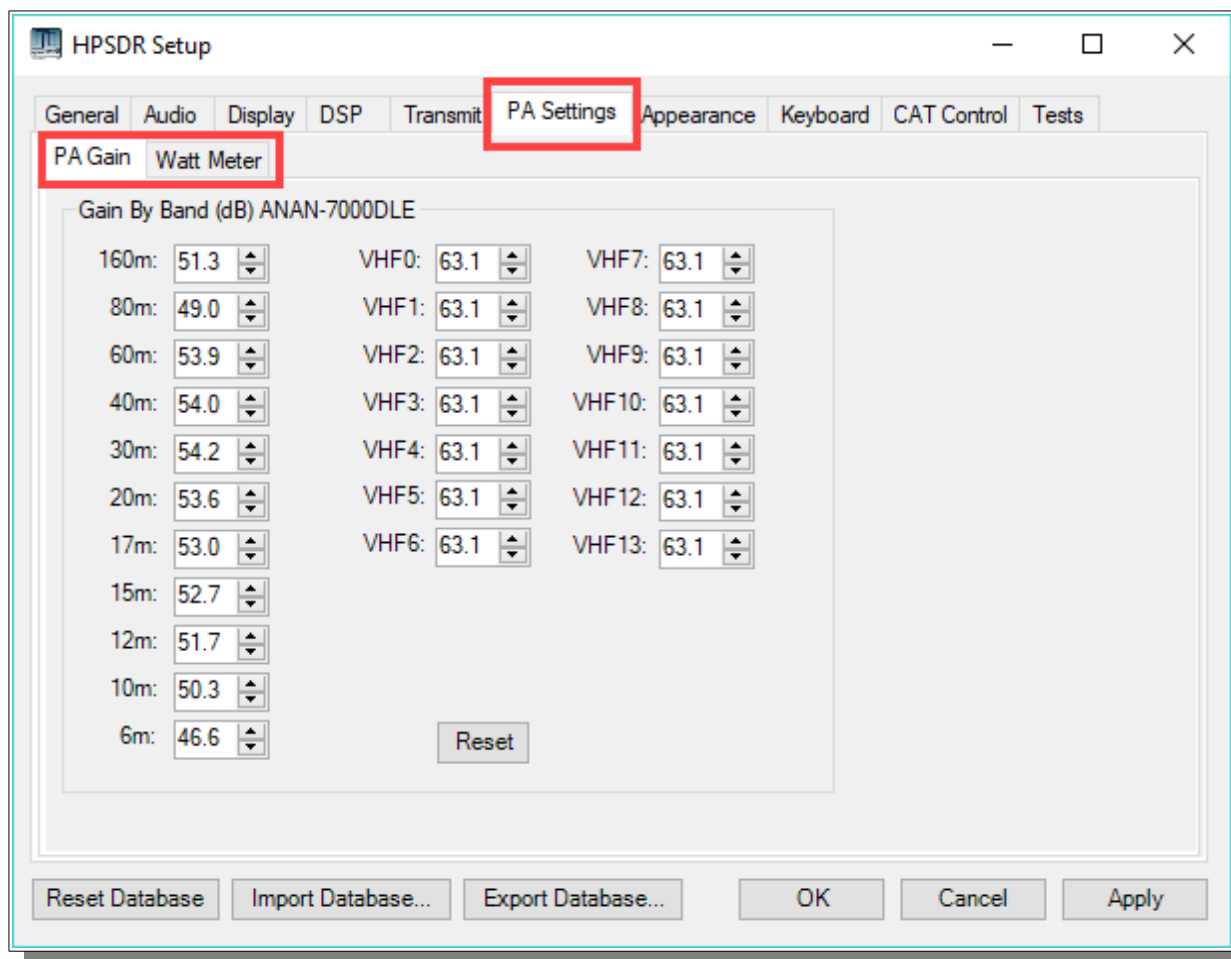

Use the following manual calibration procedure to properly set/calibrate your ANAN-7000DLE power output into a dummy load:

1. Connect a suitable Dummy Load to ANT1 BNC port on the back panel of the Transceiver.
2. Click on menu selection, Setup, Transmit.
3. Set "TUNE", Power % to 100
4. Select "FWD Pwr" from the "TX Meter" upper right corner of the console.
5. Enable the Antenna window by clicking on **Setup ---> General ---> ANT/FILTERS** tab to access the antenna settings.
6. Select the Transmit antenna ANT1 where you connected the Dummy Load.
7. Select the PA settings TAB on the Setup menu window.

The PA Settings TAB allows you to set [calibrate] the ANAN-7000DLE Power Amplifier gain by band [dB – Power Output per Band] for each of the available Ham Bands. There is an up/down gain control for each band, which regulates the Power Amplifier output for that band. **As you increase the Gain By Band, power output will decrease. Conversely, decreasing Gain By Band will increase Power Amplifier output.**

Maximum power output per band can be reached at the lowest value in this menu.

8. Select one of the bands on the PA settings TAB.

9. Ensure you have the Setup ---> Transmit tab ---> Tune control set to 10 and a **Dummy Load** connected to the selected antenna port on the ANT/FILTERS setup tab.

10. Press "TUN" [Tune] on the upper left side of the console.

11. Adjust the band gain value for a **MAXIMUM** TX Meter "FWD PWR" output reading of 10 watts while using your suitable Dummy Load. Do NOT use an Antenna for this calibration adjustment.

12. Press "TUN" button again to stop transmitting.

Repeat the above procedure for each Ham Band to properly calibrate the RF CW power output for a **MAXIMUM** of 10 watts.

13. When all bands have been calibrated, remove the Dummy Load and select the antenna of your choice in the ANT/FILTERS setup Tab.

14. Remember to reduce the "TUN" power wattage setting on the Setup ---> Transmit tab to approximately 9W.



## Computer Performance

Processing of streaming data in real-time can be a challenging task for Windows-based applications and device drivers. This is because by design Windows is not a real-time operating system. There is no guarantee that tasks can be executed in a deterministic [timely] manner.

Audio or video data streams transferred from or to an external device are typically handled by a kernel-mode device driver. Data processing in such device drivers is interrupt-driven.

Typically, the external hardware periodically issues interrupts to request the driver to transfer the next block of data. In Windows NT-based systems [Windows 2000 and later] there is a specific interrupt handling mechanism. When a device driver cannot process data immediately in its interrupt routine, it schedules a Deferred Procedure Call [DPC]. Microsoft defines them as: A Deferred Procedure Call [DPC] is a queued call to a kernel mode function that will usually be executed at a later time. DPCs are used by drivers to schedule I/O operations that do not have to take place in an ISR at a high IRQL, and can instead be safely postponed until the processor IRQL has been lowered. When you look at Windows Task Manager and sort the running processes by CPU [Processor Utilization], the System Idle Process is almost always at the top of the list. What you may not know is that 'process' is really a roll-up of several things. Among other things included in that CPU number, is hardware interrupts and DPCs. You can see these two items by using the Microsoft "SysInternals" Process Explorer available here: [Process Explorer](http://www.sysinternals.com/ProcessExplorer.aspx)

The Sycon's DPC Latency Checker is a free Windows tool that analyzes the capabilities of a computer system to handle real-time data streams properly. It may help you to determine if your personal computer is capable of powering your HPSDR system or to find the cause for interruptions in real-time audio and video streams, also known as 'drop-outs'. The program supports Windows 2000, Windows XP, Windows XP x64, Windows Server 2003, Windows Server 2003 x64, Windows Vista, Windows Vista x64, Windows 7 32 bit and 64 bit and is available here. Latency checker found by N9VV

<http://www.resplendence.com/latencymon>

and

[http://www.thesycon.de/deu/latency\\_check.shtml](http://www.thesycon.de/deu/latency_check.shtml)

## Warranty

We warrant that our products are free of defects in material and workmanship and extend this warranty under intended use and normal service conditions to the original owner for a period of 12 months from the date of purchase. This warranty does not apply to any product that has been repaired [Unauthorized] or altered in any manner and is void if damaged by accident, neglect, unreasonable use, improper installation, lack of proper impedance matching [High SWR], improper tuning, over driving power limits, damage due to use of any third party accessories, or any other cause not arising specifically out of defects in material or workmanship.

Our obligations are limited to repairing or replacing, at our sole discretion, any product or part that is returned to the mailing address, all shipping or transportation charges must be pre-paid, accompanied by proof of purchase and which examination reveals to have been defective within the warranty period stated above.

Our Warranty does not imply any obligation other than herein stated. Any implied warranties, including but not limited to fitness for a particular purpose, are limited in duration for the above one year period.

We shall not be liable under this warranty, or any implied warranty, for loss of use of the product or for any other consequential loss or damage incurred by the purchaser.

[Warranty -- Apache Labs website](http://www.apache-labs.com/terms-of-use.html) has a link to explain their warranty and other pertinent information: <http://www.apache-labs.com/terms-of-use.html> under "Terms of Use".

## IMPORTANT

The FPGA and other components on the ANAN-7000DLE PCBs can be damaged by Electrostatic Discharge [ESD]. When handling the PCB, you should take ESD precautions [e.g. use a work bench with an antistatic mat on it and wear a grounded wrist strap].

When powered on do not touch the top of any IC in order to determine its temperature. In particular, do not touch the Switch Mode Regulator IC. Touching its leads can change the switching frequency and alter the output voltage.

## MARS operation

In PowerSDR select **Settings** → **General** → **Hardware Config** → **Region** you will be able to select band limits by country or Region. Use care in selecting the "Extended" Region.

## APIPA Automatic Private IP Addressing

**Definition: APIPA** is a [DHCP](#) failover mechanism for local networks. With APIPA, DHCP clients can obtain IP addresses when DHCP servers are non-functional. APIPA exists in all modern versions of Windows. If your new ANAN-7000DLE Transceiver is connected **directly** to your PC, you will probably get an APIPA address.

If a DHCP server fails, APIPA allocates IP addresses in the private range 169.254.0.1 to 169.254.255.254. When the DHCP server is again able to service requests, clients update their addresses automatically.

In APIPA, all devices use the default network mask 255.255.0.0 and all reside on the same [subnet](#).

APIPA is enabled on all DHCP clients in Windows unless the computer's Registry is modified to disable it. APIPA can be enabled on individual network adapters.

Your current IP address, Firmware revision, and MAC address are all clearly displayed on the **Setup** → **General** → **Hardware Config** menu panel [shown below].

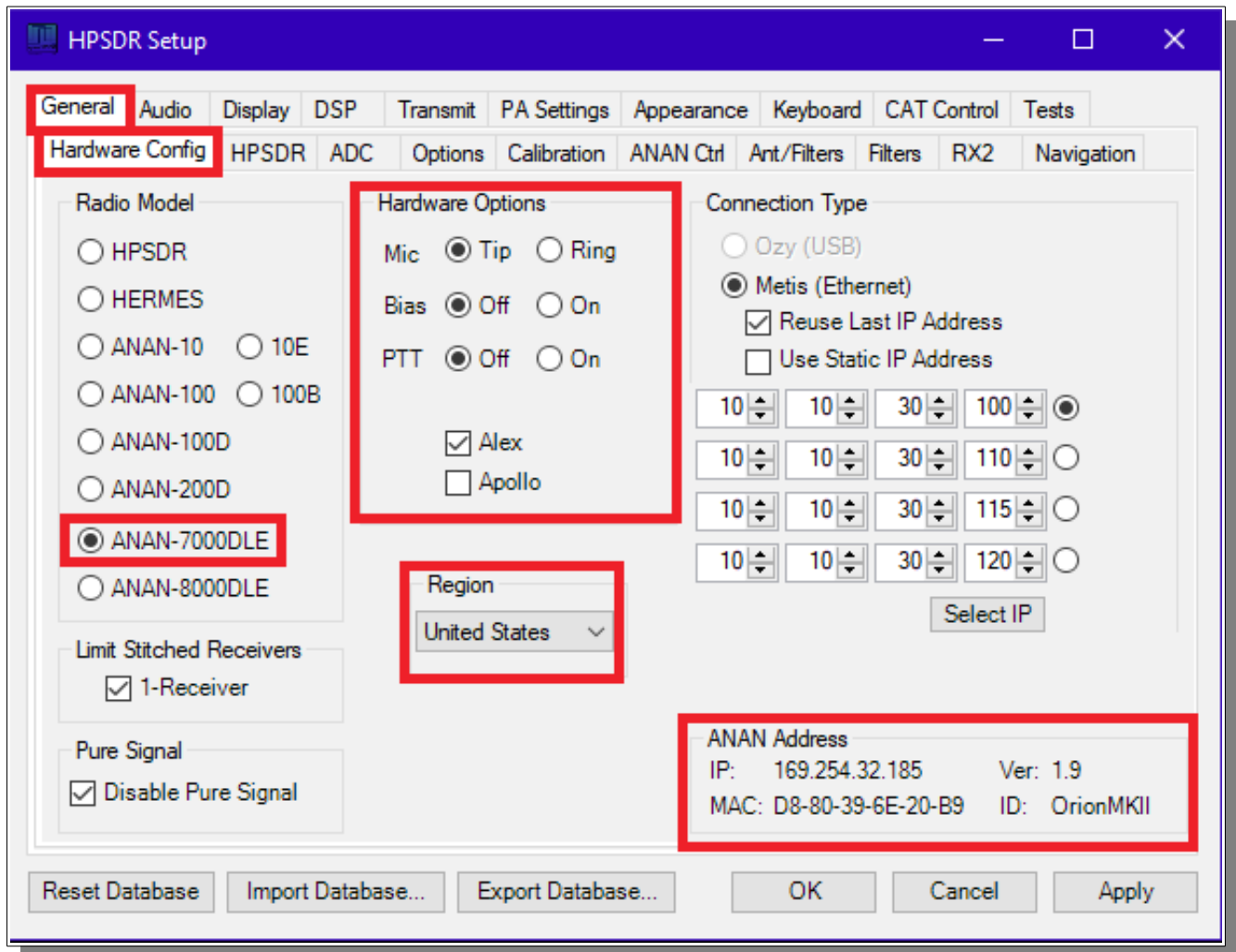

Apache Labs Orion MkII PCB

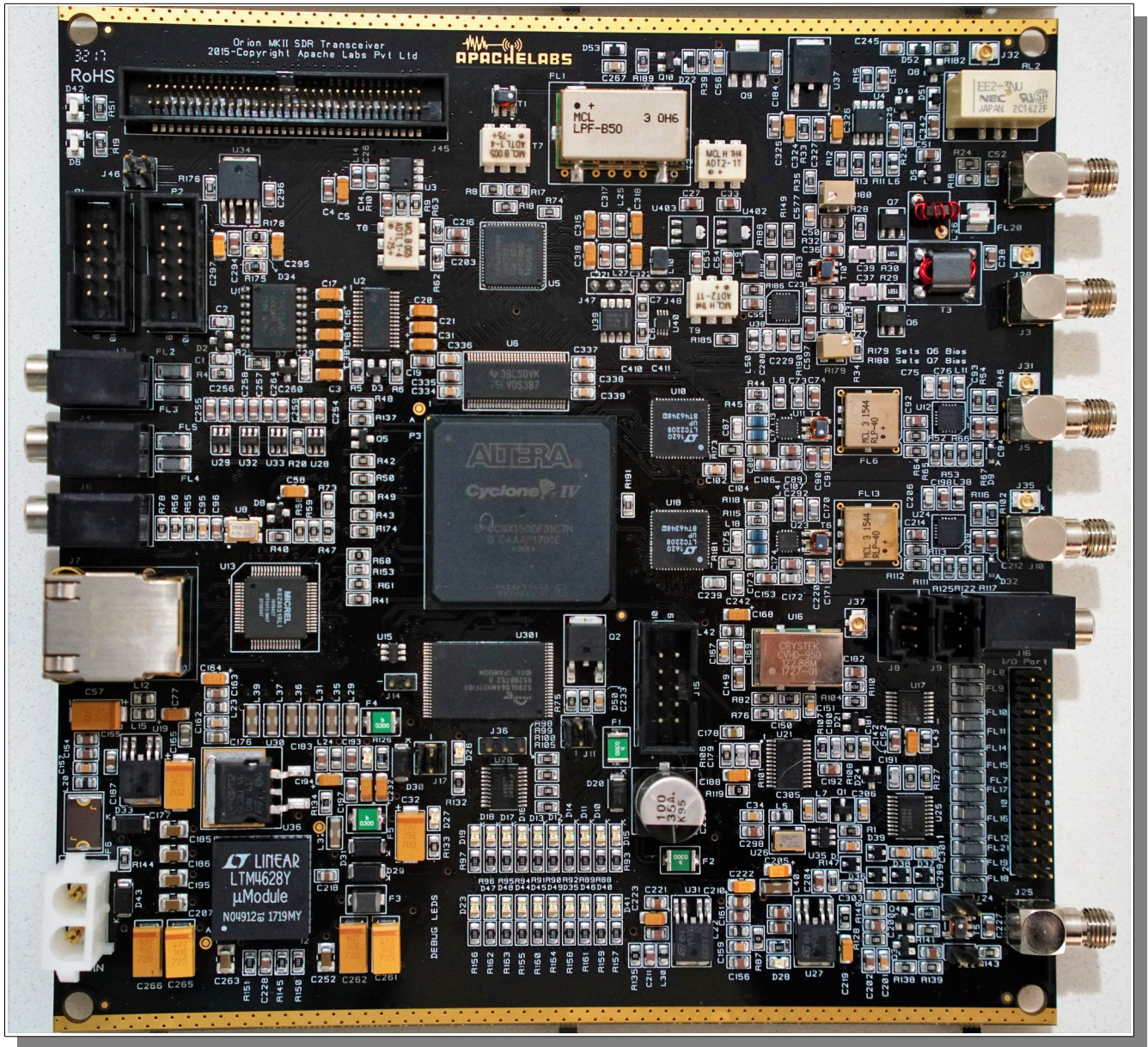

Apache Labs Orion MkII v5.2



# ANAN-7000DLE PA/FILTER PCB

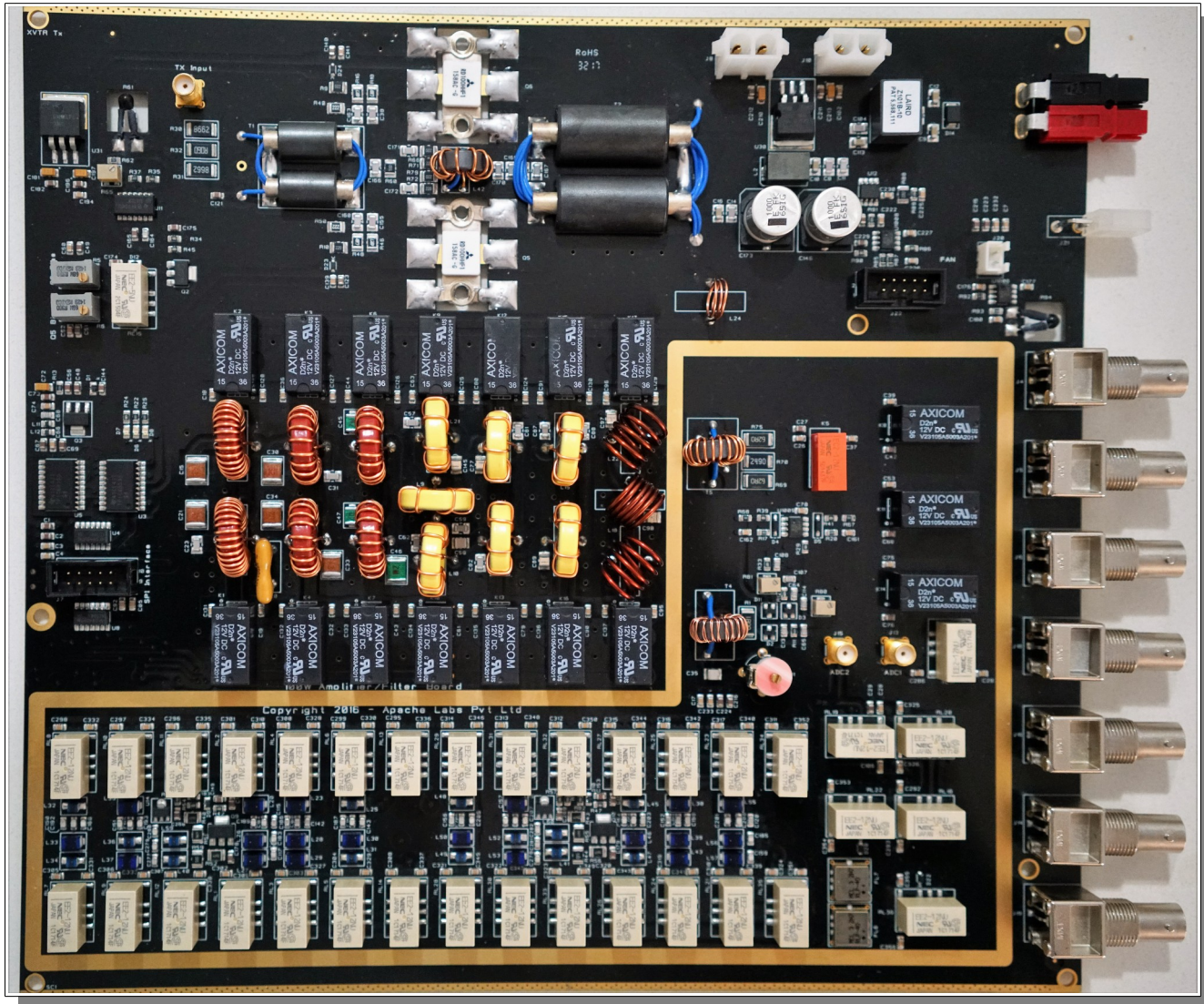

**APACHE LABS**  
 Copyright 2017 – Apache Labs Pvt Ltd  
 Based on the work of the OpenHPSDR Community  
 ANAN-7000DLE

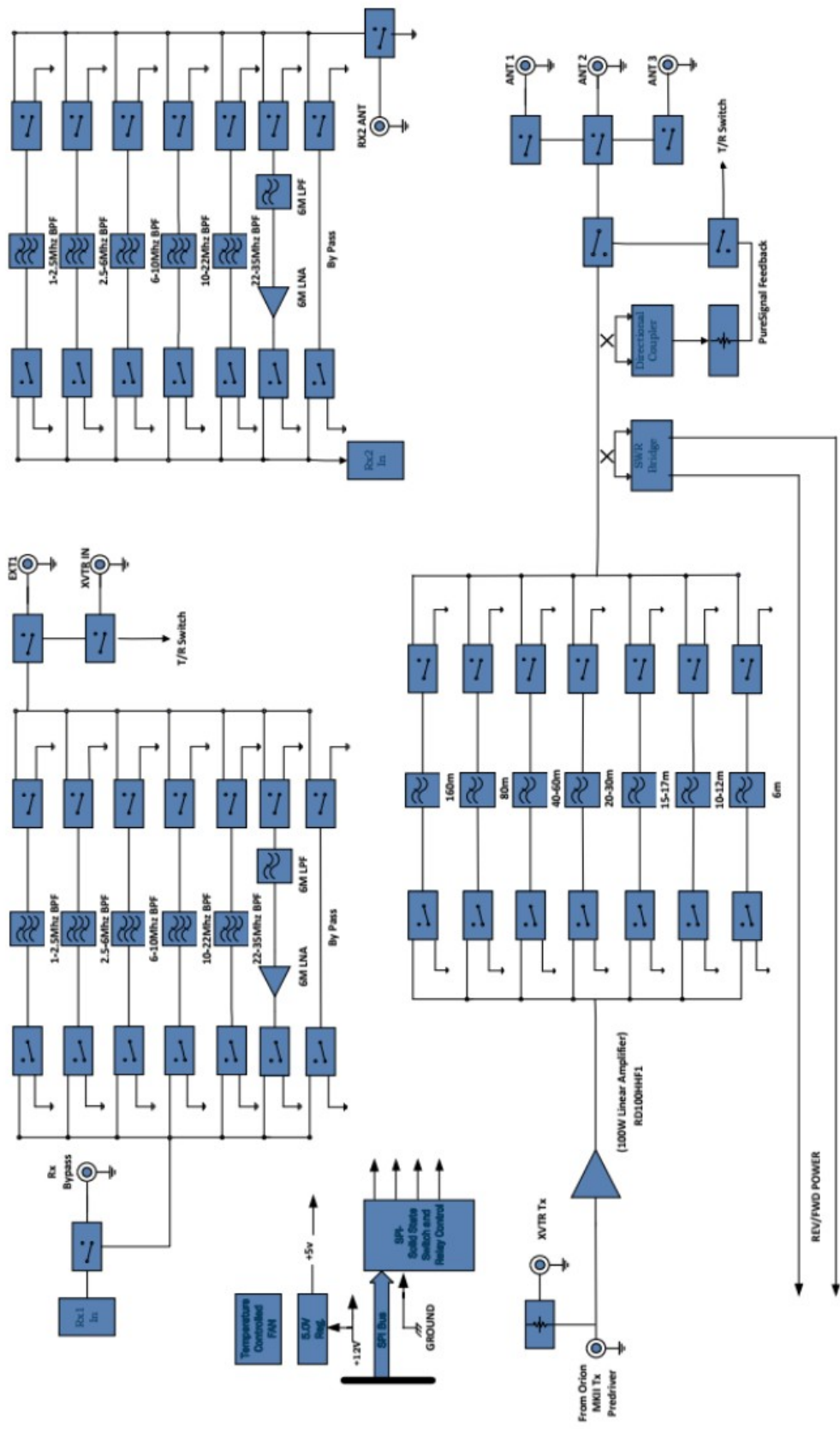

## Appendix

### Apache Schematics

The ANAN-7000DLE schematic are available by request from Apache Labs LLC.

Balanced Audio Input is not implemented in the current Apache Labs Transceivers.

The LEFT LINE level input is currently selectable in PowerSDR as an alternative to the mic input. Balanced audio is not supported by the CODEC hardware used in the ANAN radios. If a balanced input is required then an external balanced to unbalanced transformer [or active electronic equivalent] will be required.

### Independent versions of PowerSDR software

#### Multiple independent .xml databases

Go to the Properties of the shortcut.

At the end of the Target you can add the new directory path using the command line argument `-datapath:<"directory path">`

To create a new directory for the ANAN-7000DLE radio I use the name PowerSDR ANAN\_7K like this:

```
start -datapath:"%appdata%\FlexRadio Systems\PowerSDR ANAN_7K\"
```

My new Target will look like this:

```
"C:\Program Files [x86]\OpenHPSDR\PowerSDR mRX PS\PowerSDR.exe"  
-datapath:"%appdata%\FlexRadio Systems\PowerSDR_7K\"
```

When you start PowerSDR using the modified shortcut you will receive this message the first time.

Ensure the directory path is correct. The click on Yes.

You will then get the normal startup with a new wisdom file and database created in the new folder.

## Updating the ANAN-7000DLE Firmware

The FPGA bootloader code resides in protected portion of lower segments of flash memory. The FPGA firmware fits in the address range above the bootloader code.

Depending on the position of the bootloader switch, either the bootloader code or the radio firmware is transferred to the FPGA for execution.



### **FPGA Heartbeat LED**

Note: There is an FPGA "Heartbeat" LED located on the front of the Transceiver PCB that will blink every second to indicate that the FPGA firmware is properly installed and active for communication with the LCD Panel microprocessor.

When running the HPSDRProgrammer\_v2.0.4.10 utility, you can update the FPGA Firmware code. The update files are available from <https://github.com/TAPR/OpenHPSDR-Firmware>. Firmware Update files will have the ".rbf" suffix. The HPSDRProgrammer utility is specifically designed so you cannot inadvertently overwrite or damage the lower bootloader addresses.

## HPSDRProgrammer v2.0.4.10

Download the HPSDRProgrammer installer for Windows [HERE](#).

Install the HPSDRProgrammer software.

Connect the radio to your computer network using an ethernet cable. Power the radio ON. Wait a couple of minutes for the radio to initialize. Connecting the radio and computer together with the ethernet cable recommended over using a switch, router or WiFi connection.

Run the HPSDRProgrammer software.

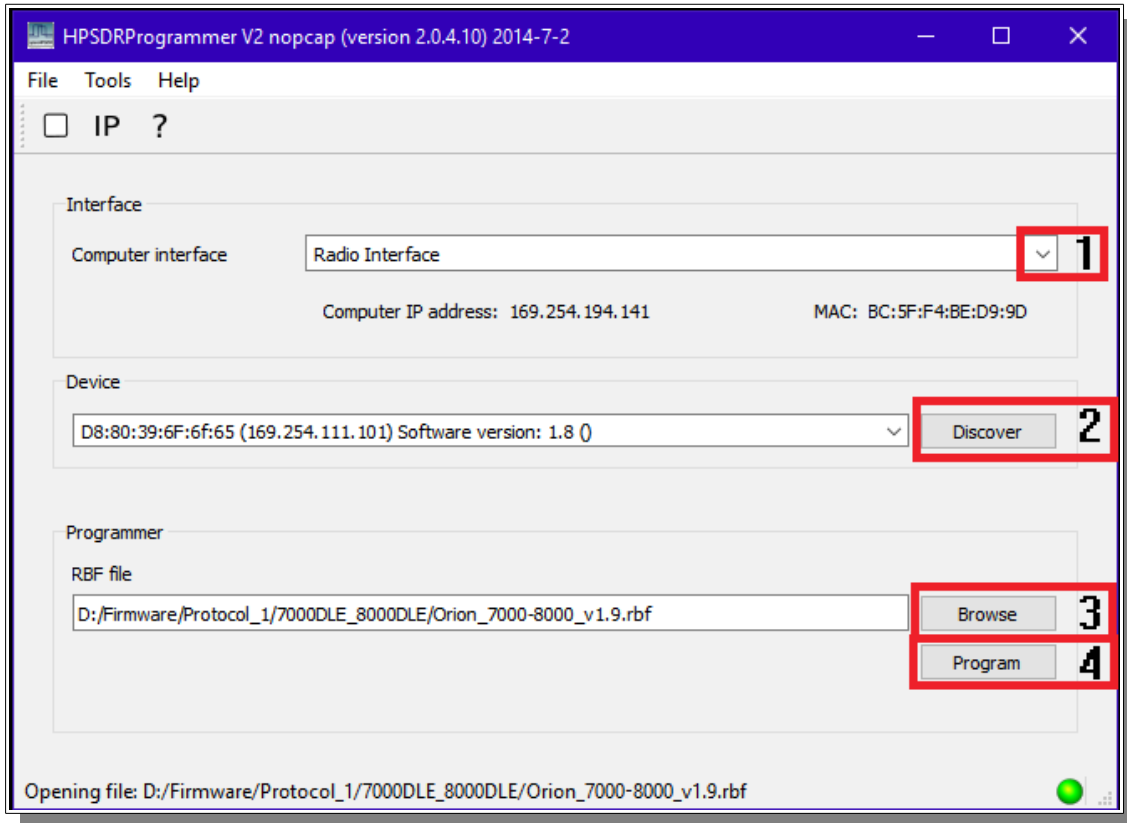

1 – Choose the **Computer Interface** that the radio is connected to using the pull-down menu.

2 – Click on **Discover**. Wait until the information is updated in the **Device** field.

3 – **Browse** to the location of the firmware file you will be using to update the radio.

4 – Click on **Program** to flash the firmware.

Firmware files are available for download from [HERE](#).

## Assign Static IP Address using HPSDRProgrammer

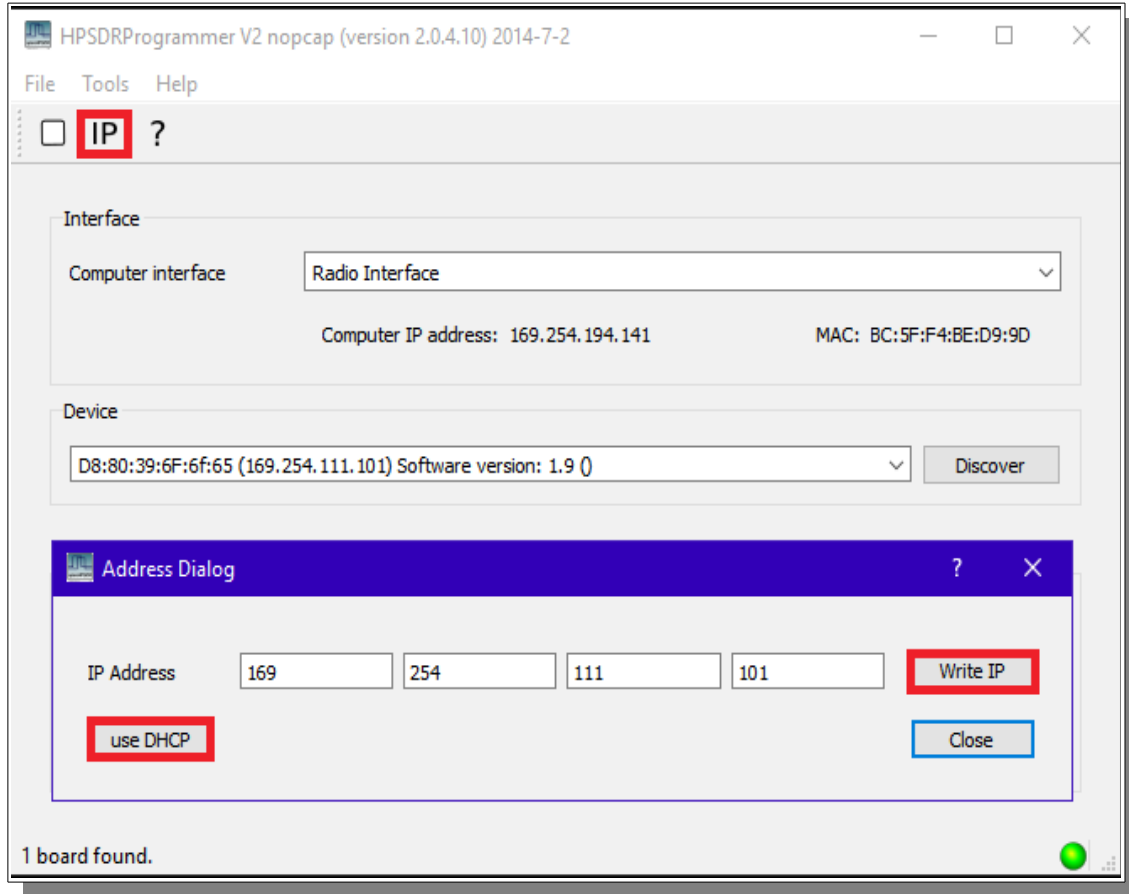

- 1 – Choose the correct **Computer Interface** and **Discover** the radio on the network.
- 2 – Click on **IP** from the menu.
- 3 – Enter the new IP address in the **IP Address** fields.
- 4 – Click on **Write IP** to update the IP address in the radio.

To revert back to using **DHCP** or **APIPA** click on **use DHCP**.

## HPSDRBootloader v2.0

Download the HPSDRBootloader installer for Windows [HERE](#).

Install the HPSDRBootloader software.

Connect the radio to your computer network using an ethernet cable. Place the radio into bootloader mode using the slide switch on the bottom panel. Power the radio ON. Having a direct ethernet connection between the radio and computer is highly recommended and in some cases will be required.

Run the HPSDRBootloader software.

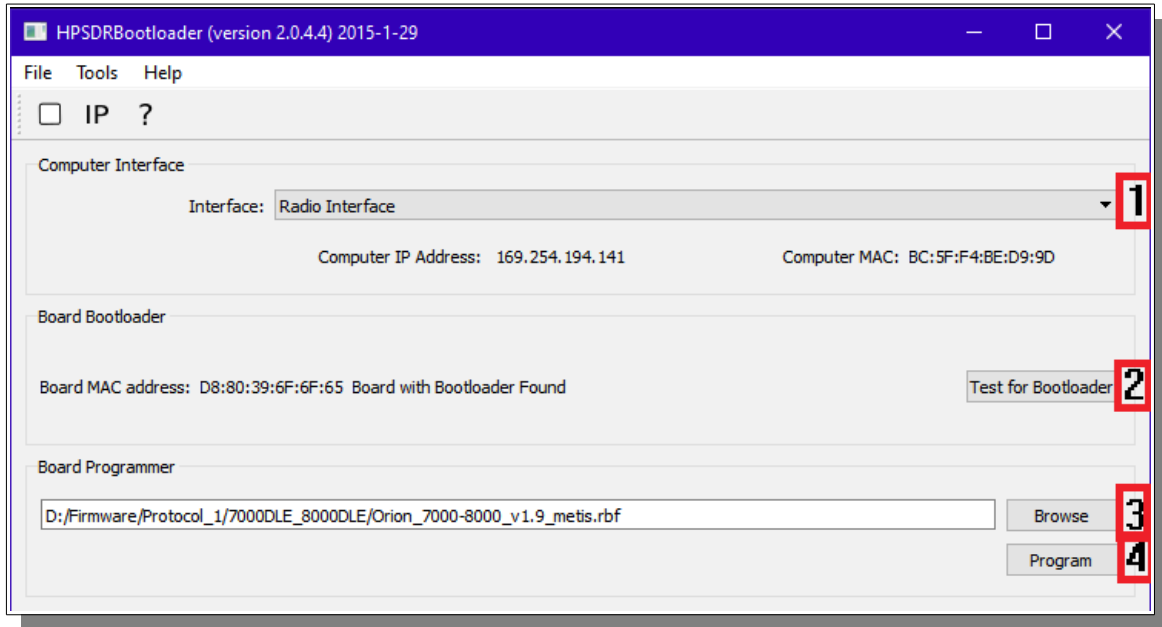

- 1 – Choose the **Computer Interface** that the radio is connected to using the pull-down menu.
  - 2 – Click on **Test for Bootloader**. Wait until the information is updated in the **Board Bootloader** field.
  - 3 – **Browse** to the location of the firmware file you will be using to update the radio.
  - 4 – Click on **Program** to flash the firmware.
- Firmware files are available for download from [HERE](#).

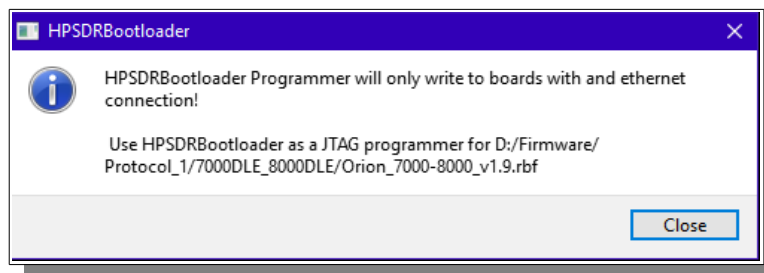

If you receive this error message, rename the rbf file adding the word **metis** to the file name. In my example I added it to the end.

## Assign Static IP Address using HPSDRBootloader

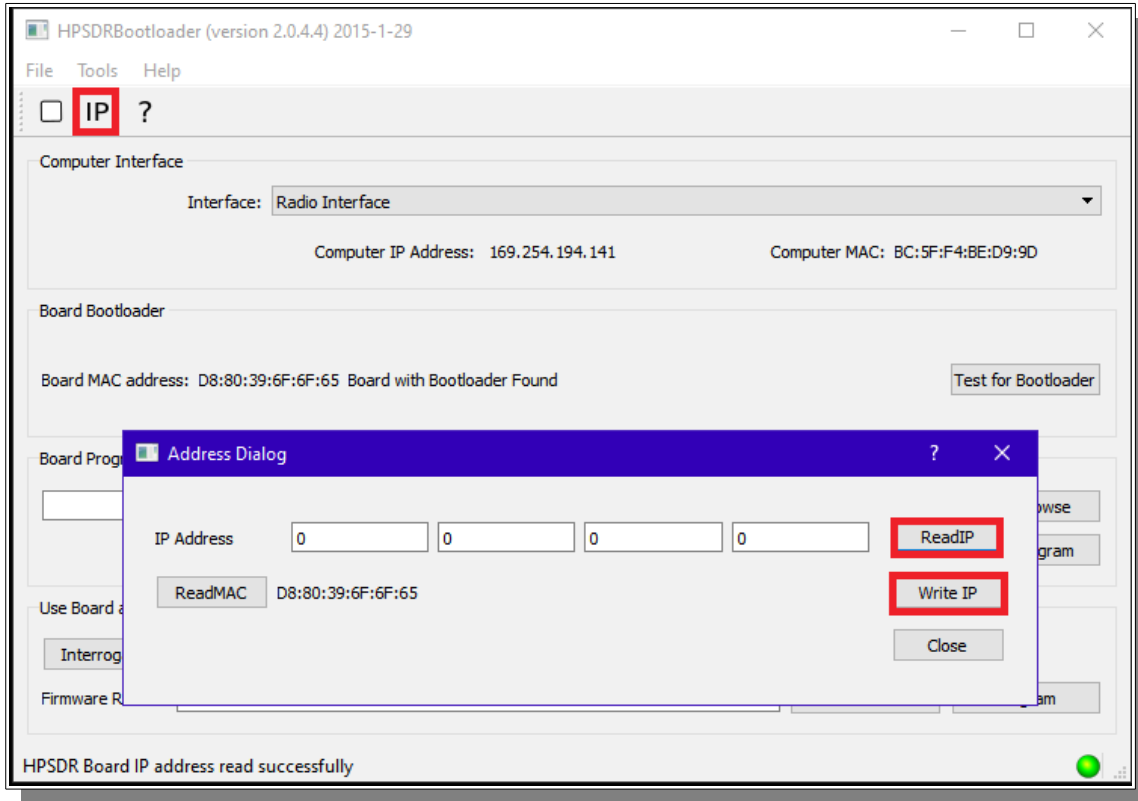

- 1 – Choose the correct **Computer Interface** and then **Test for Bootloader**.
- 2 – Click on **IP** from the menu.
- 3 – Click on **ReadIP** to read the current IP address of the radio.
- 4 – Enter the new IP address in the **IP Address** fields.
- 5 – Click on **Write IP** to update the IP address in the radio.

To revert back to using **DHCP** or **APIPA** enter **0.0.0.0** in the **IP Address** fields and click on **Write IP**.



